



**SPH 3000-6000TL-HUB Series  
User Manual**

## About this Document

This manual is prepared to provide detailed product information and installation instructions for users of the SPH series products manufactured by Shenzhen Growatt New Energy Technology Co., Ltd. (hereinafter referred to as Growatt). Please read this manual carefully and keep it in a place that is convenient for installation, operation and access. Growatt reserves the right to make any modifications to this manual without further notification to customers.

Only professional electrical engineers certified by relevant departments are allowed to install the SPH inverter. The installer must read this manual carefully for safe and fast installation, troubleshooting, and smooth operation.

If you have any questions during the installation process, you can log in to [www.growatt.com](http://www.growatt.com) and leave a message. You can also call our 24-hour service hotline at +86 755 2747 1942.

SPH 3000-6000TL-HUB Series are compatible with both lead-acid and lithium batteries, it should be noted that the lithium batteries must be supplied by GROWATT. GROWATT can only provide lithium battery that is compatible with inverter, no lead-acid battery will be provided by Growatt as customer can easily buy these from the market.

SPH 3000-6000TL-HUB Series comes with an all-in-one structure, ready to connect to the battery and combine them into one unit; to facilitate installation and for your safety, you must use Growatt ALP 5.0L-E1 lithium batteries.

The ALP 5.0L lithium battery should be separately purchased. If needed, please contact your distributor, visit our website to leave a message ([www.growatt.com](http://www.growatt.com)) or call our service line (+86 755 2747 1942).



# Contents

<b>1 Product Introduction .....</b>	<b>1</b>
1.1 Intended Use .....	1
1.2 System Diagram.....	2
1.2.1 SPH 3000-6000TL-HUB .....	2
1.2.2 ALP 5.0L-E1 .....	4
<b>2 Safety .....</b>	<b>6</b>
2.1 General Safety.....	6
2.2 Safety Precautions .....	6
2.2.1 Environment Requirements.....	6
2.2.2 Safe Operation and Protection Measures .....	7
2.3 Label Description .....	8
2.4 Emergency Responses.....	12
<b>3 Storage and Transportation .....</b>	<b>13</b>
3.1 Storage Requirements.....	13
3.2 Transportation Requirements .....	13
<b>4 Installation and Cable Connections .....</b>	<b>14</b>
4.1 Basic Installation Requirements .....	14
4.2 Installation Tools .....	15
4.3 Installation Procedure .....	16
4.3.1 Checking before Installation .....	16
4.3.2 Floor-mounted Installation .....	19
4.3.3 Wall-mounted Installation.....	23
4.4 Electrical Connection.....	28
4.4.1 Communication Terminal Wiring between Bms/ between BM and SPH.....	28
4.4.2 Power Terminal Wiring between BMs/between BM and SPH.....	29
4.4.3 EPS Connector Wiring Instructions .....	29
4.4.4 Grid Connector Wiring Instruction .....	33
4.4.5 AC-side Cable Specification Recommendation .....	34
4.4.6 PV Connector Wiring Instructions .....	34
4.4.7 Datalogger Installation Instructions.....	35
4.4.8 System Wiring.....	36
4.4.9 External Communication Port Installation.....	39

4.4.10 PE Cable Wiring Instructions.....	46
4.4.11 System Wiring Instructions .....	47
4.5 Install the decorative cover .....	53
<b>5 Power on/off the System .....</b>	<b>55</b>
5.1 Power on the System .....	55
5.2 Power off the System .....	55
5.3 Power on/off the battery system separately .....	56
5.3.1 Power on the battery system .....	56
5.3.2 Power off the battery system .....	56
<b>6 Commissioning and Maintenance .....</b>	<b>57</b>
6.1 Commissioning .....	57
6.1.1 Working Mode Description .....	57
6.1.2 LCD Screen and Button Description .....	59
6.2 Datalogger Settings.....	73
<b>7 Specifications.....</b>	<b>74</b>
7.1 ALP 5.0L-E1 Specifications .....	74
7.2 SPH 3000-6000TL-HUB Specifications .....	76
<b>8 Troubleshooting .....</b>	<b>80</b>
8.1 SPH Fault List and Troubleshooting Suggestions.....	80
8.2 Battery Fault List and Troubleshooting Suggestions.....	84
8.3 Decommissioning .....	85
8.3.1 Preparation.....	85
8.3.2 Remove the Inverter.....	86
8.3.3 Pack the Inverter .....	86
8.3.4 Dispose of the Inverter .....	86
8.4 Alarm Notifications.....	86
8.4.1 Requirements for Remote Communication .....	86
8.4.2 Setting up Remote Reporting .....	87
8.4.3 Check Historical Alarms.....	89
<b>9 Appendix.....</b>	<b>90</b>
9.1 Other Optional Accessories .....	90
9.2 Safety Standards.....	90

# 1 Product Overview

## 1.1 Intended Use

The SPH grid-connected system consists of PV modules, SPH 3000-6000TL-HUB inverter, ALP series batteries, public grid and others, as shown in Figure 1. It comes with two independent MPPTs. Up to 8 batteries can be connected in parallel. In addition, the SPH has an EPS output port with a maximum on/off-grid switching time of 15ms, which can be used as backup power when working with the battery.

**The SPH series includes the following six models:**

SPH 3000TL-HUB

SPH 3600TL-HUB

SPH 4000TL-HUB

SPH 4600TL-HUB

SPH 5000TL-HUB

SPH 6000TL-HUB

They are hereinafter referred to as "SPH".

Note: We offer the SPH of different power levels in different countries. For example, in Germany, we can provide SPH 3000TL-HUB, SPH 4600TL-HUB, while SPH 5000TL-HUB and SPH 6000TL-HUB are not available.

Highlights of SPH series inverters:

1. Intelligent management. Three working modes are available: Load First, Battery First and Grid First, enabling diverse application scenarios.
2. Highly compatible inverter and battery, ensuring advanced battery safety.
3. Easy to install. Modular design, with integrated smart meter.
4. Two independent photovoltaic MPPT inputs.
5. Support parallel connection of multiple inverters.
6. Eight battery modules can be used in parallel, substantially expanding the capacity and power of the energy storage system.
7. ALP 5.0L features excellent charge and discharge performance, accurate status monitoring, long cycle life, and minimum self-discharge loss.
8. The entire battery system communicates with the power conversion system (inverter) through CAN, supporting the following functions to ensure the safe operation of the battery:
  - Monitoring: Detect the voltage, current and temperature of each cell and battery pack.
  - Protection and alarm: Generate alarms and provide protection for over-voltage, under-voltage, over-current, over-temperature or under-temperature.
  - Report: Report all alarms and status data to the inverter.
  - Power off due to fault: after 25 minutes of power outage or 2 minutes of under-voltage protection.

## 1.2 System Diagram

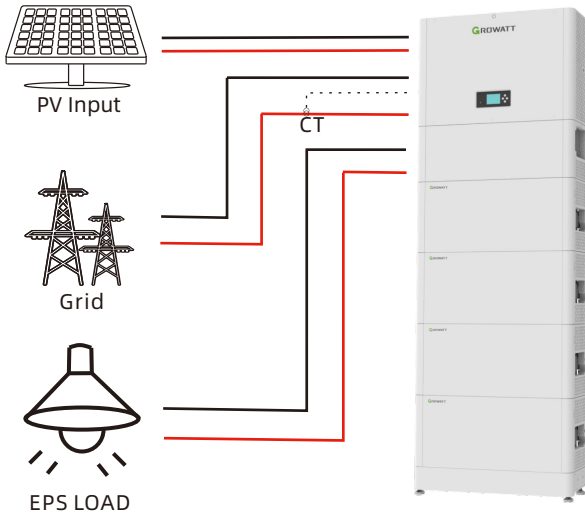
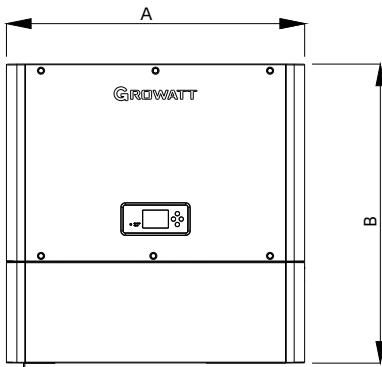

Figure 1.1 System diagram of the SPH

### 1.2.1 SPH 3000-6000TL-HUB

The SPH 3000-6000TL-HUB inverter is mainly composed of inverter circuit, buck-boost converter circuit, control circuit and communication circuit. The product appearance is shown below:

A: Dimensions of SPH 3000-6000TL-HUB



Dimensions(unit:mm)

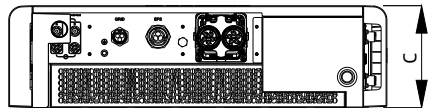

Figure 1.2 Appearance of the SPH

	A (mm)	B (mm)	C (mm)	Weight(kg)
SPH 3-6KTL-HUB	690	692	186	35

B: External terminals of SPH

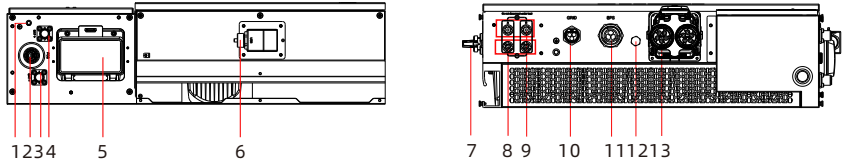



Figure 1.3 Wiring terminals of SPH

1	Ground point	Common ground point for the battery and the SPH inverter
2	CAN Port	Connected to the battery CAN communication port
3	BAT- terminal	Connected to the negative battery terminal
4	BAT+ terminal	Connected to the positive battery terminal
5	Battery circuit breaker	Used to turn on/off the battery overcurrent protection circuit breaker
6	USB Port	Connected to the datalogger and USB flash drive
7	PV Switch	Switch-disconnector to turn on/off the PV input
8	PV+ terminal	Connected to the positive input of the PV panel, including PVA+ and PVB+
9	PV- terminal	Connected to the negative input of the PV panel, including PVA- and PVB-
10	GRID terminal	Connected to the grid
11	EPS terminal	Supplying power to the loads
12	Ventilation valve	Maintaining the same pressure inside and outside of the equipment while keeping it watertight
13	Communication port	For communication and data transmission between the inverter and external devices

C: Button description

Symbol	Designation	Description	
	Push button	Operate the display screen and set system parameters	
	SPH status indicator	Steady green	SPH runs normally
		Steady red	Fault state
		Blinking green	Alarm state
		Blinking red	2. Software updating

1.2.2 ALP 5.0L-E1

The ALP 5.0L-E1 consists of a battery module (including battery cells and mechanical components), a battery management system (BMS), and the power supply and communication terminals. The product appearance is shown below:

A: Dimensions of ALP 5.0L-E1  
Dimensions (unit: mm)

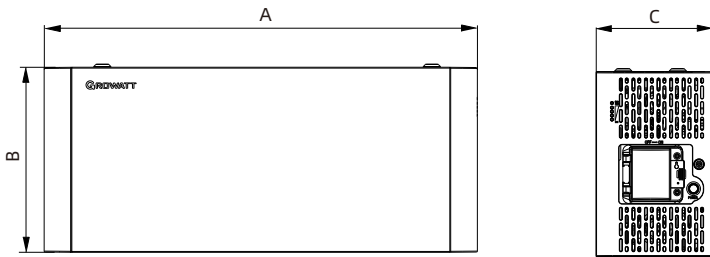
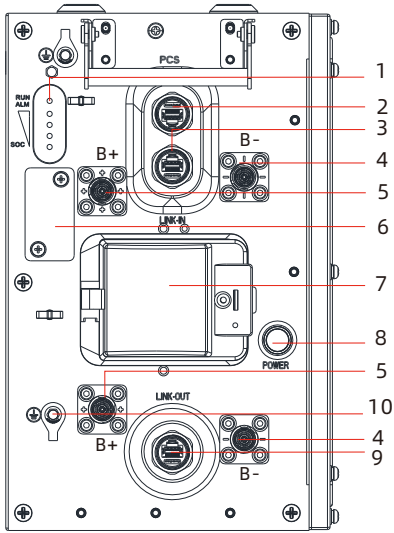

Figure 1.4 Dimensions of the ALP 5.0L-E1

	A (mm)	B (mm)	C (mm)	Weight(kg)
ALP 5.0L-E1	690	295	185	44

B: External terminals of ALP 5.0L-E1



1	LED
2	PCS CAN communication port
3	LINK-IN CAN communication port
4	Negative battery terminal
5	Positive battery terminal
6	USB port
7	DC Breaker
8	Battery power button
9	LINK-OUT CAN communication port
10	Battery ground point

Figure 1.5 Wiring terminals of ALP 5.0L-E1

C: Battery indicator description

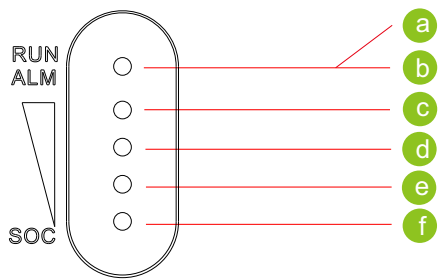

Figure 1.6 ALP 5.0L-E1 LED indicators

No.	Name	Color	Description
A	RUN	Green	Normal operation
B	ALM	Red	Failure or protection status
C	LED 4	Blue	76%-100%
D	LED 3	Blue	51%-75%
E	LED 2	Blue	26%-50%
F	LED 1	Blue	0%-25%

# Safety 2

When installing or operating the battery system, the safety information contained in this section must always be followed. For safety reasons, it is the installer's responsibility to get familiar with this manual and all warnings before installation.

## 2.1 General safety

The inverter and battery has been designed and tested in accordance with international safety requirements. As with all electrical or electronic devices, there are residual risks despite careful construction. Before installing or using the equipment, please read the instructions carefully and observe the all safety precautions at all time. Growatt shall not be liable for any consequence of the following circumstances:

- Damage during the transportation by the customer.
- Damage caused by improper operations of a third part or customer, including those in transportation, storage, installation and use of the product.
- Improper installation by unprofessional and uncertified personnel.
- Failure to follow the operation instructions and safety precautions provided in this document.
- Unauthorized modifications or removal of the software package.
- The product's tamper evident label is removed or any item is missing due to customer's negligence or intentional damage.
- Operating the equipment in environments that cannot meet the requirements specified in this document.
- Damage caused by repairing, disassembling, and modifying the product without authorization.
- Tampering with labels on the chassis or modifying the date of production.
- Battery modules are left uncharged for more than six months.
- Damage due to force majeure, such as lightning, earthquakes, fire, and storms.
- Warranty expiration.

## 2.2 Safety Precautions

### 2.2.1 Environment requirements

- Do not expose the equipment to environments where the temperature is beyond the range of 0-50°C or any heat source; otherwise the battery would fail to work normally.
- Do not install or use the battery in a humid place with corrosive gases or liquids, such as the bathroom.
- Do not expose the equipment to direct sunlight for extended periods.
- Place the equipment in a safe place and ensure that they are not accessible to children and animals.
- Battery power terminals shall not come in contact with conductive objects such as wires.





















- Do not dispose the batteries in a fire, which may cause an explosion.
- Do not put the battery in contact with liquids.
- For indoor installation, do not install the equipment in the bedroom, living room, kitchen, etc.
- For outdoor installation, please build a sun and rain shelter to protect the equipment from direct sunlight, rain or snow. lation, do not install it in the bedroom, the living room and the kitchen, etc.

### **2.2.2 Safe Operation and Protection Measures**

1. This manual contains important information about your operating system. Please read the manual carefully before operation. Follow all instructions in the manual strictly, otherwise it may cause device damage, personal injury and property loss, or void the product warranty. Keep the manual handy for maintenance and repair;
2. Use appropriate measuring equipment when connecting or testing the system to ensure the electrical parameters comply with requirements. Be sure to connect and use matching specifications to prevent arcing or shock. Ensure that the whole system has been reliably grounded;
3. Do not repair or maintain the equipment in wet weather. Do not touch the SPH system with wet hands;
4. It is strictly prohibited to disassemble the SPH system without permission. If the equipment requires maintenance, please contact your local designated system installation and maintenance personnel. Only qualified and trained personnel are allowed to repair, replace or maintain the SPH system;
5. Before installation, replacement and maintenance, please remove all metal objects that may cause short circuits, such as watches, rings, etc.;
6. Do not crush, drop or puncture the battery pack and SPH inverter;
7. Comply with local safety regulations when disposing of the batteries.
8. When storing and transporting the SPH system, do not stack them without packaging boxes. When stacking the battery packages, observe the stacking requirements on the outer packaging;
9. Handle the battery carefully to avoid leakage. Leaked electrolyte is toxic and harmful to skin and eyes;
10. Do not use damaged, faulty or deformed batteries. These batteries may release flammable gases, causing fire or other safety hazards;
11. Please be clear about the battery type you desire, lithium or lead-acid. If the wrong battery type is selected, SPH will fail to work properly;
12. All electrical installations must comply with local electrical safety standards;
13. Ensure that you have obtained approval from the utility company before connecting equipment to the power grid;
14. Turn off the PV switch when installing PV modules during the day; otherwise the voltage of the module terminal would be too high under sunlight, leading to safety hazards.

## 2.3 Label Description

Label	Description
	Risk of high voltages which might lead to electric shocks
	Burn hazard. Hot surface. Do not touch.
	Delayed discharge: Residual voltage exists after the SPH is powered off. Wait at least 5 minutes until it discharges to the safe level
	Grounding: indicates the position for connecting the PE cable
	Direct current (DC)
	Alternating current (AC)
	CE marking This product complies with the requirements of the applicable EU directives
	Li-ion batteries can be recycled
	Danger! Explosive gas
	Be aware of battery leakage
	Heavy object! Moving the equipment without help of other people might cause injury
	Keep the inverter out of children's reach.

Label	Description
	Ensure the correct polarity
	Keep away from open flames and heat source
	Refer to the manual
	Do not dispose of the product together with the household waste but in accordance with the disposal regulations for electronic waste applicable at the installation site
	Regulatory Compliance Mark (RCM) for Australia
 <b>WARNING</b>	Indicates a potentially hazardous situation, if not avoided, could result in serious injury or death



**DANGER**

**Risk of high voltage!**

- Only professional personnel are allowed to perform the operation.
- Keep children, people with disabilities and non-professionals away from the system.
- Supervise and make sure children don't play near the installation position of inverter machine.



**DANGER**

**Risk of burns! Do not touch a running SPH.**

It generates high temperature on the cover, chassis and heat sink during operation.



### CAUTION

The SPH inverter emits radiate, which might affect your health aversely!

Do not stay close to the SPH inverter (within 20 cm) for a long time.



### Grounding the SPH inverter

#### Information

Please ensure that SPH inverter has been securely connected to ensure personal safety.







  Lithium Ion Battery	
Model	ALP 5.0L-E1
Nominal Voltage	51.2V
Nominal/Rated Capacity	100Ah/90Ah
Nominal/Rated Energy	5000Wh/4600Wh
Rated Current	75A
Ingress Protection	IP66
Operating Ambient Temperature	0°C ~ +50°C
Protective Class	I
Maximum Short Current and Duration	500A,50us
    Made In China	

Figure2. 1 Battery module label







  Lithium Ion Battery	
System Model / Rated Current / Nominal Capacity / Rated Capacity / Nominal Energy / Rated Energy	<input type="checkbox"/> ALP 5.0L-E1/75A/100Ah/ 90Ah/5.0kWh/4.6kWh
	<input type="checkbox"/> ALP 10.0L-E1/100A/200Ah/ 180Ah/10.0kWh/9.2kWh
	<input type="checkbox"/> ALP 15.0L-E1/100A/300Ah/ 270Ah/15.0kWh/13.8kWh
	<input type="checkbox"/> ALP 20.0L-E1/100A/400Ah/ 360Ah/20.0kWh/18.4kWh
	<input type="checkbox"/> ALP 25.0L-E1/100A/500Ah/ 450Ah/25.0kWh/23.0kWh
	<input type="checkbox"/> ALP 30.0L-E1/100A/600Ah/ 540Ah/30.0kWh/27.6kWh
	<input type="checkbox"/> ALP 35.0L-E1/100A/700Ah/ 630Ah/35.0kWh/32.2kWh
	<input type="checkbox"/> ALP 40.0L-E1/100A/800Ah/ 720Ah/40.0kWh/36.8kWh
Nominal Voltage	51.2V
Ingress Protection	IP 66
Operating Ambient Temperature	0°C ~ +50°C
Protective Class	I
    Made In China	

Figure2. 2Battery module number label

**WARNING**

- Do not disassemble or alter the PACK to avoid overheating , explosion or fire.
- Do not use the PACK beyond the specified conditions. Which may cause heat generation,damage, or declining performance.
- Do not throw, drop, hit, drive a nail into or stamp on the PACK. It may cause heat generation, explosion or fire.
- In case of an electrolyte leakage, do not approach the PACK.Should you come into contact with the electrolyte,seek immediate medical attention.
- Do not put the PACK into a fire. Do not expose it to high temperature or heat sources, such as fire sources and heaters to avoid overheating, explosion, or fire.
- Do not submerge the battery in water or get it wet, which may cause heat generation, explosion and fire.
- Avoid a reverse polarity battery connection.
- Do not allow battery terminals to contact with other metals.
- Exercise caution when moving the heavy objects to avoid injuries.
- Ensure that the PACK is not accessible to children and animals.

Figure2. 3 Battery usage safety warnings

**GROWATT**

Hybrid Inverter  
SPH 6000TL-HUB

---

**PV Input Data**

Max. PV voltage	600 d.c.V
PV voltage range	100-560 d.c.V
PV Isc	24 d.c.A*2
Max input current	16 d.c.A*2

---

**AC Input /Output Data**

Rated input/output power	6000 W
Rated output apparent power	6000 VA
Nominal voltage	230 a.c.V
Rated input/output current	26 a.c.A
Nominal frequency	50/60Hz
Power factor range	0.8leading~0.8lagging

---

**Stand Alone Data**

Nominal AC output power	6000 VA
Nominal AC output voltage	230 a.c.V
Rated output current	26 a.c.A
Nominal AC output frequency	50/60Hz

---

**Battery Data**

Battery voltage range	42-59 d.c.V
Rated charging and discharging current	125 d.c.A
Type of battery	Lithium/Lead-acid

---

**Others**

Overvoltage category	PV:II BAT:II AC:III
Safety level	Class I
Ingress protection	IP66
Operation ambient temperature	-25°C~+60°C
Inverter topology	Non-isolated
Certificate number	

---

Integrated with AFCI

---

Download  
Manual

Made in China

Figure 2. 4 Inverter label

Be sure that the operating ambient temperature is between 0 and 50°C, otherwise the battery will stop working.

**WARNING**

## 2.4 Emergency Responses

The manufacturer has taken foreseeable risk scenarios into consideration and designed the battery system to mitigate the hazards. In case of an emergency, do as below:

Emergency	Description and suggested measures
Leakage emergency	<p>Avoid contact with leaked liquids or gases. Should you come into direct contact with the battery electrolyte, do as follows:</p> <ul style="list-style-type: none"><li>• Eye contact: flush your eyes with flowing water for 15 minutes, and seek immediate medical attention.</li><li>• Skin contact: wash the affected area with soap and water, and seek immediate medical attention.</li><li>• Ingestion: seek immediate medical attention.</li></ul>
Fire emergency	<p>Normally, the battery system won't ignite spontaneously. If a fire occurs, do not try to extinguish the fire but evacuate people immediately.</p>
Flood emergency	<ul style="list-style-type: none"><li>• Power off the system while ensuring personal safety.</li><li>• If any part of the battery is submerged by water, do not touch the battery to avoid electric shock.</li><li>• Do not use batteries that have been flooded. Contact a battery recycling company for disposal.</li></ul>
Shell damage	<p>The shell damage requires extra attention as it is of high risk. Do not use batteries with a damaged shell, which may cause safety hazards. Contact Growatt or your distributor to dispose of them.</p>

# 3 Storage and Transportation

## 3.1 Storage Requirements

- Handle the batteries according to the signs on the packing case.
- Do not put batteries upside down or on their side.
- Do not store damaged batteries near undamaged ones.
- Do not stack more than 4 units in one line when storing the inverter and battery and do not stack them without packages.
- The storage environment requirements are as follows:
  - 1) Store the SPH in a dry, clean and well-ventilated place.
  - 2) Relative humidity: 5% to 95% RH.
  - 3) Place the SPH system away from corrosive and organic materials.
  - 4) Protect the batteries against direct sunlight and rain.
  - 5) Keep the SPH system at least two meters away from heat sources (such as a radiator).
  - 6) Recommended battery storage temperature: -20°C to 50°C (storage duration: one week); -20°C to 40°C (storage duration: over 6 months).
  - 7) If the battery module has not been used for more than 6 months, it needs to be recharged. In this case, a recharge device is required. For details, please contact Growatt customer service.
  - 8) Avoid exposure to intense infrared radiation.

## 3.2 Transportation Requirements

This product has been certified to comply with UN38.3 (Section 38.3 of the sixth Revised Edition of the Recommendations on the Transport of Dangerous Goods: Manual of Tests and Criteria) and SN/T 0370.2-2009 (Part 2: Performance Test of the Rules for the Inspection of Packaging for Exporting Dangerous Goods). The battery pack belongs to Class 9 dangerous goods.

Transportation requirements are as follows:

- The SPH system shall not be transported with other flammable, explosive or toxic substances.
- Ensure that the original package and labels are intact and identifiable.
- Avoid direct exposure to sunlight, rain and condensing water caused by temperature difference.
- There might be a drop in capacity during transportation and storage.
- Keep the temperature between -20°C to 45°C and the relative humidity within the range of 5%~95% RH during transportation.

# Installation and Cable Connections 4

	<ul style="list-style-type: none"><li>➤ Read through this manual before installation to get familiar with the product information and safety precautions.</li><li>➤ Only qualified and well-trained technicians who fully understand the whole photovoltaic system, grid network, battery system, working principle and national/local standards are allowed to perform operations on the SPH system.</li><li>➤ Installers must use insulating tools and wear safety gear during operation.</li><li>➤ Device damage caused by failure to comply with the storage, transportation, installation or operation requirements specified in this document is not covered under any warranty.</li><li>➤ Do not install or use the SPH system near explosive or inflammable materials.</li><li>➤ Operate the SPH system in a well-ventilated environment with temperature ranging from -10°C to 50°C. For outdoor installation, build a sun &amp; rain shelter to avoid exposure to direct sunlight and rain.</li><li>➤ The SPH system should be protected from dust and dirt. Do not expose it to environments with high humidity.</li></ul>
---	---

**WARNING**

## 4.1 Basic Installation Requirements

Observe the following installation requirements:

- A. The installation location must be able to bear the weight of the SPH system for a long time.
- B. Do not install the SPH system on a structure made of flammable or thermally unstable materials.
- C. When installing the SPH system outdoors, it is recommended to install an awning above the system to avoid exposure to sunlight and rain; otherwise it may cause damage to the system.
- D. Inlet protection level: IP66; pollution level: PD2.

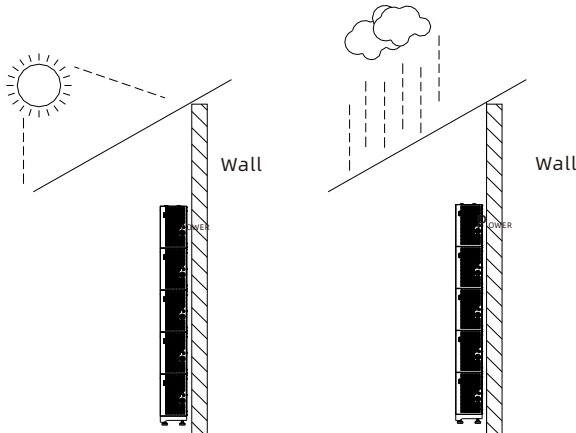

Figure 4. 1 Outdoor installation requirements



E. Observe the clearance requirements:

- 1) Keep the SPH at least 600 mm away from any heat source such as the water heater, gas heater, air conditioner or any other equipment.
- 2) Keep a distance of at least 600 mm from the outlet.
- 3) Keep a distance of at least 600 mm from a window or other vent.
- 4) Do not install the SPH in restricted locations defined in AS/NZS 3000.
- 5) Refer to the installation steps for additional clearance requirements.

F. The installation location should be free from obstacles for the use of disconnecter.

G. Do not install this system near a television antenna or any other antenna or antenna cable.

H. Do not install the system in living areas.

I. Ensure that the system is inaccessible to children.

J. Take the system dimensions into account when determining the installation location. Please refer to the user manual for the relevant dimensions.

K. Do not place flammable and explosive dangerous goods around the system to avoid severe danger.

L. If installed on a non-flame-retardant structure, it is recommended to add a flame-retardant device between the SPH system and the installation structure.

M. During the battery system installation process, the ambient temperature should be maintained between 0°C~50°C, and the humidity should be kept between 5%~95%.

N. Do not turn the system module upside down and make sure the floor is level.

O. If installed indoors, please ensure proper ventilation.







**WARNING**

Do not place the system modules upside down and make sure the floor is level.

Up to 4 battery modules can be stacked in a single column. If more than 4 BMs are to be configured, please install them in two rows.

## 4.2 Installation Tools

The following tools are required to install the system:

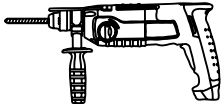
 Allen key (5mm <sup>2</sup> )	 Cross-head screwdriver	 Wrench (10mm <sup>2</sup> )
 Measuring tape	 Multimeter	 Hammer drill

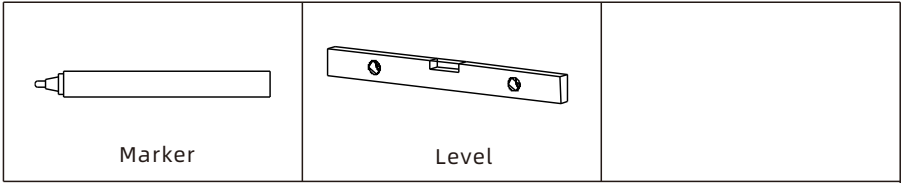

Figure 4. 2 Installation tools

Please wear the following safety gears:



Figure 4. 3 Safety gears

## 4.3 Installation Procedure

### 4.3.1 Checking before Installation

- Check the package before unpacking it. If any damage is found, do not unpack the package and contact your distributor.
- Check the quantity of all components according to the packing list. If any damage is found or any component is missing, please contact your distributor.

#### 4.3.1.1 Check components of systems in different capacities

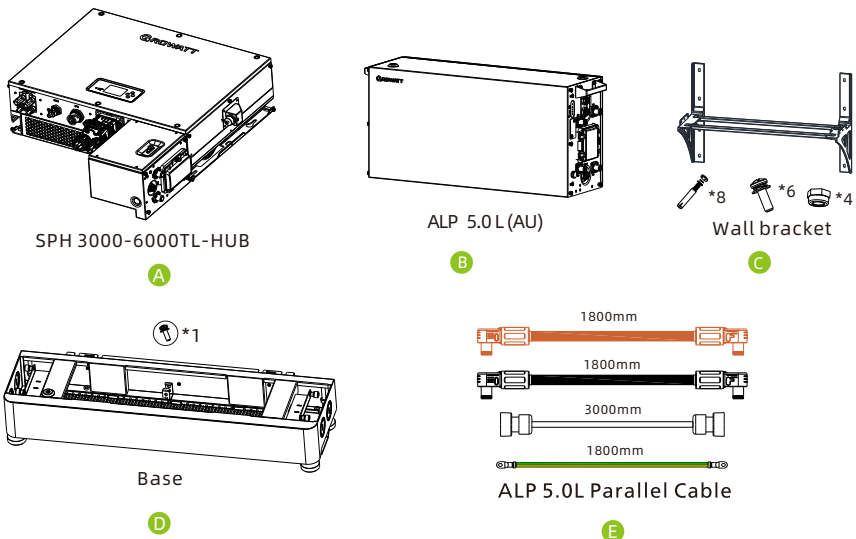

Figure 4. 4 Configuration of the SPH System in different capacities

**NOTE:**

1. The wall mount bracket and the base do not come as standard. Please select the optional accessory based on your installation method (as shown in Chapter 4.3.2 or 4.3.3);
2. Cables in Figure E are not standard accessories. They are required only when installing 5 (or above) battery modules in parallel. In case that you need to purchase the parallel cables, please contact Growatt after-sales services.
3. "N" stands for the number of the battery module.
4. The SPH 3000-6000TL-HUB All-in-One Inverter must work with at least one ALP 5.0L Battery Module (BM).
5. You can choose the floor-mounted installation or wall-mounted installation. The system configurations are shown below:

Installation Method	Compound Mode
Standard wall-mounted installation	A*N+B+D
Standard floor-mounted installation	A*N+C+D
Wall-mounted battery system stacked in two lines	A*N+B*2+D+E
Floor-mounted battery system stacked in two lines	A*N+C*2+D+E

**4.3.1.2 Packing list of the SPH 3000-6000TL-HUB**

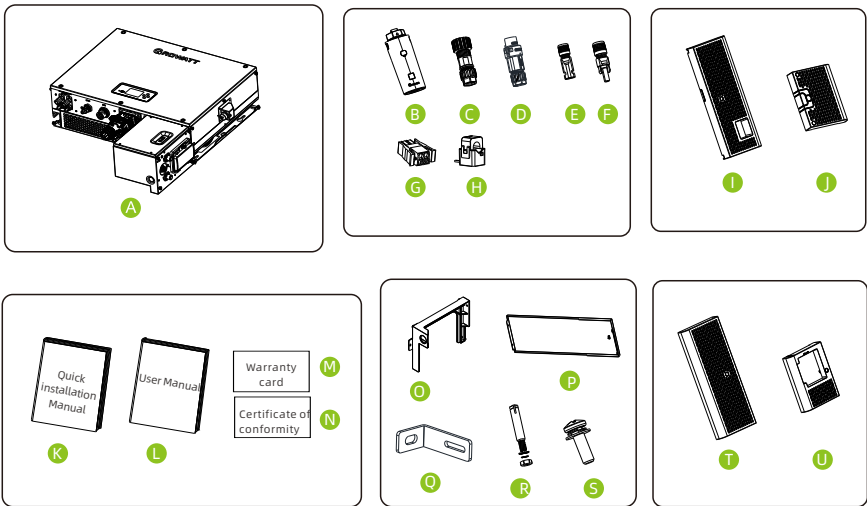
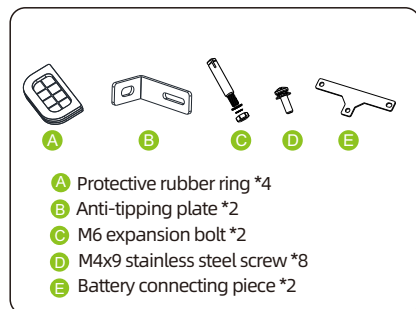
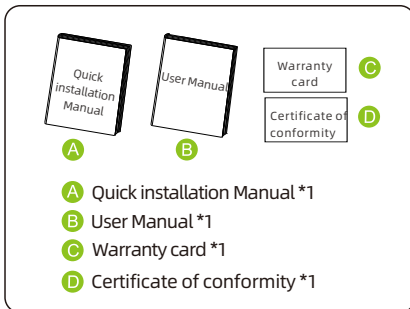
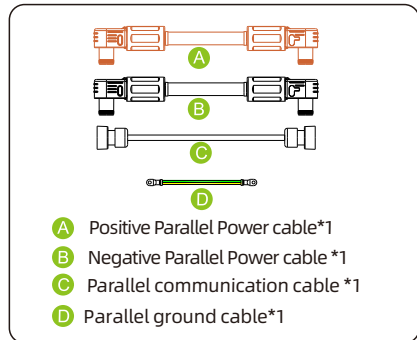
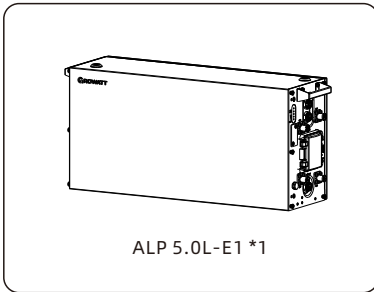
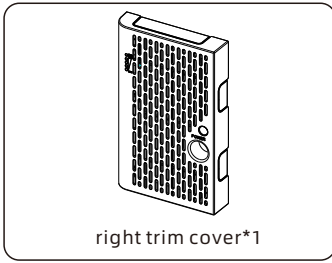

Figure 4. 5 Packing list of the SPH series inverter

A	SPH TL-HUB*1	B	ShineWiFi*1
C	EPS connector*1	D	AC Grid connector*1
E	VP-D4 connector*2	F	VP-D4 connector*2
G	COM port connector*1	H	CT*1
I	Upper left decorative cover*1	J	Lower left decorative cover*1
K	Quick installation Manual *1	L	User Manual *1
M	Warranty card *1	N	Certificate of conformity *1
O	Die cast bracket*1	P	Small junction box decorative cover*1
Q	Anti-tip connecting piece*2	R	M6 expansion screw*2
S	M4 cross recessed pan head three combination screw*9	T	Upper right decorative cover*1
U	Lower right decorative cover*1		

#### 4.3.1.3 Packing list of the ALP 5.0L-E1





right trim cover\*1

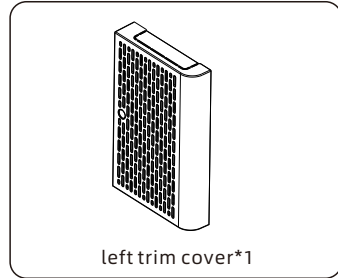

left trim cover\*1

Figure 4. 6 Packing list of the battery module of the SPH system



**NOTICE**

For an SPH system, only one SPH inverter is required, and 1-8 battery modules can be configured.

### 4.3.2 Floor-mounted Installation

**NOTE:**

1. The battery base must be installed for floor-mounted installation.
2. A maximum of 4 battery modules can be stacked in one column. If more than 4 of them are to be configured, please install them in two columns.
3. If stacking 4 battery modules in one column cannot meet the clearance requirements, please install them in two columns.
4. When installing 4 battery modules in one column, the load-bearing capacity of the floor should be greater than 300 kg.

**Step 1:** Make sure that the installation location is suitable for the dimensions of the system and the load-bearing capacity of the floor meets the requirements.

Unit: mm

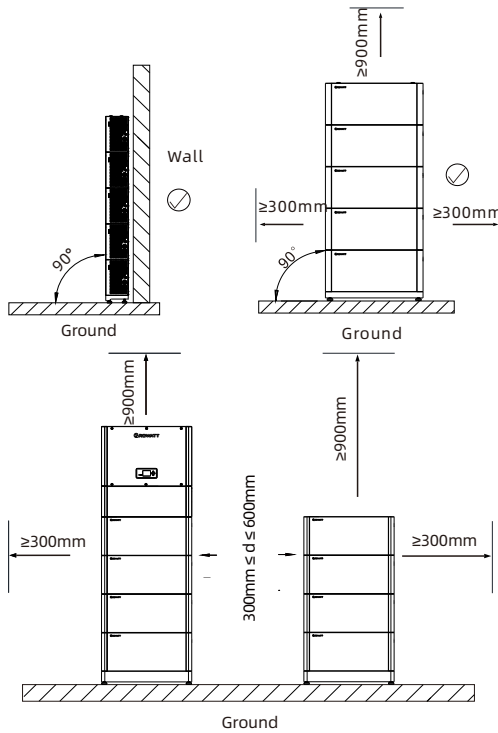

Figure 4. 7 Installation angle and clearances for floor-mounted installation

**Step 2:** Position the first BM onto the base and mark the hole positions for fixing the first BM using a marker.

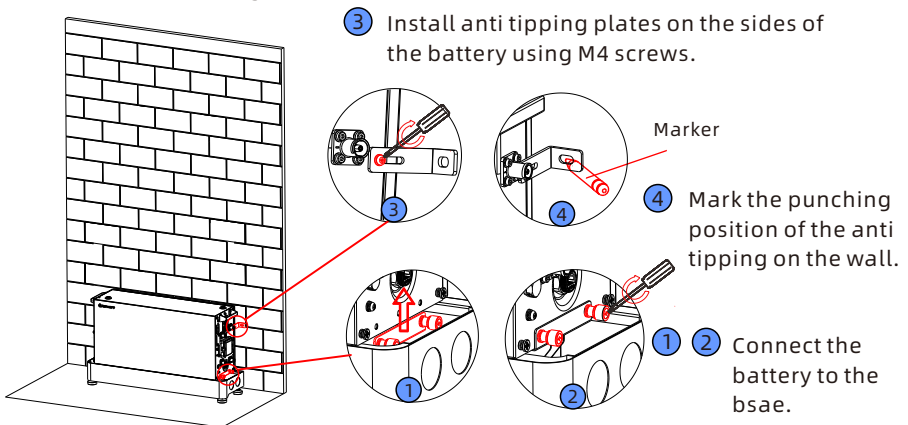

Figure 4. 8 Install the base and determine the position for the first BM

**Step 3:** Mark all hole positions with the paper drilling template and drill holes.

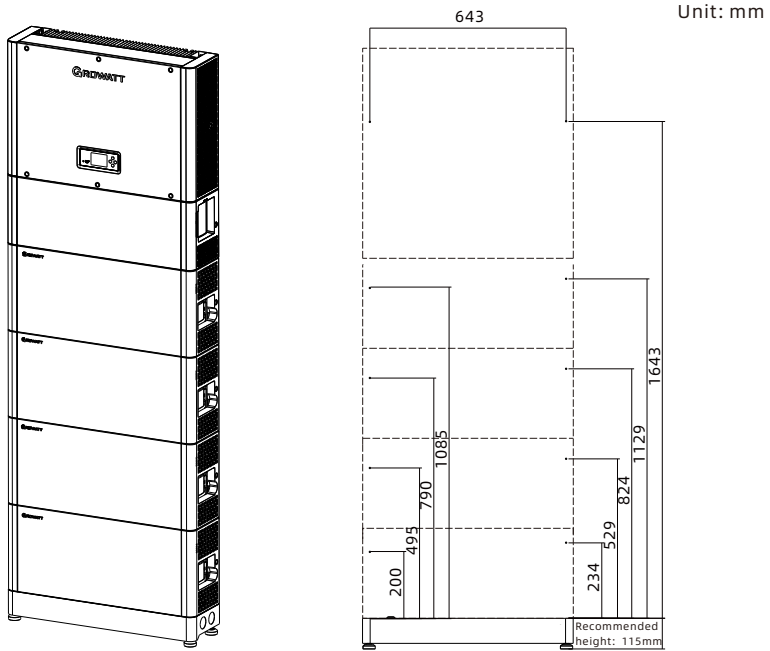
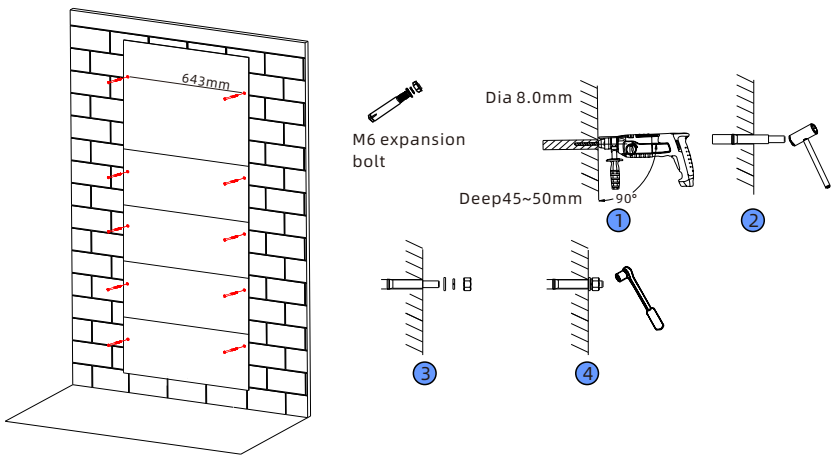

Figure 4.9 Dimensions of the drilling template



- ① Remove the battery, mark the hole positions to install the batteries.
- ① ② ③ ④ Install the M6 expansion bolt and tighten the nut.

Figure 4. 10 Hole positions and drill holes

**Step 4:** Install and secure the BMs in turn.

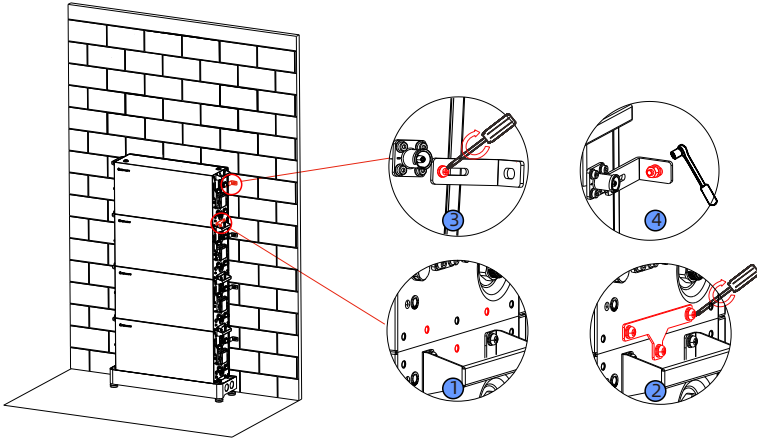

- ① ② Secure the connecting pieces on the both sides of the battery module using the M4 screws, and tighten the 6 screws.
- ③ Install the connecting pieces on both sides and tighten the 2 screws.
- ④ Install the anti-tipping plates on both sides to fix the modules to the wall.

Figure 4. 11 Secure the BM

**Step 5:** Install the die cast bracket and the .

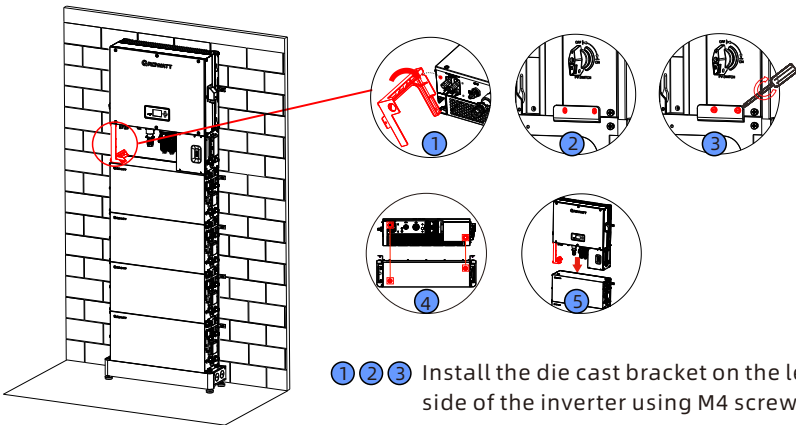

- ① ② ③ Install the die cast bracket on the left side of the inverter using M4 screws.
- ④ ⑤ When installing inverter, please note that the bottom depression of the inverter aligns with the protrusion of the battery.

Figure 4. 12 Position the SPH inverter



**Step 6:** Secure the inverter and install the decorative cover.

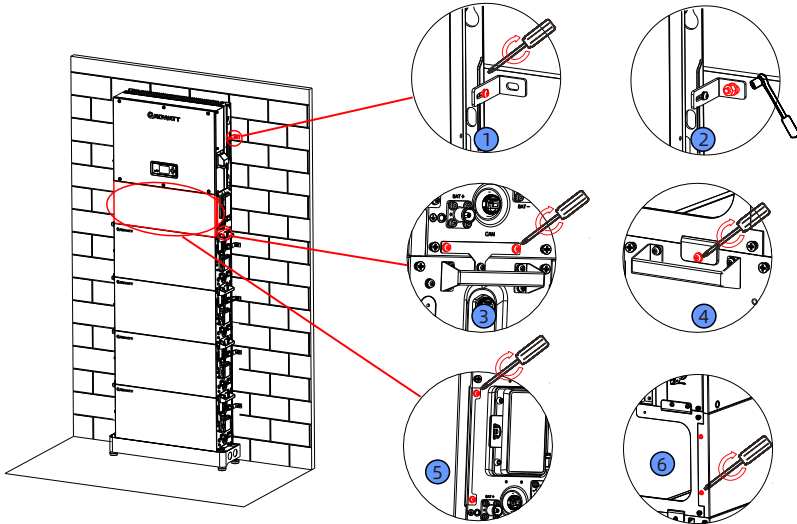

- ① ② Fix the anti tipping component to the inverter and wall using M4 screws and expansion screws respectively.
- ③ Install the connecting piece between inverter and battery using M4 screws.
- ④ Fix the inverter die-casting bracket to the battery using M4 screws.
- ⑤ ⑥ Install the inverter front panel and secure it with M4 screws.

Figure 4. 13 Secure the SPH and install the decorative cover

### 4.3.3 Wall-mounted Installation

**NOTE:**

1. A maximum of 4 battery modules can be stacked in one column. If more than 4 of them are to be configured, please install them in two columns.
2. When installing 4 battery modules in one column, the load-bearing capacity of the wall should be greater than or equal to 660 kg.

**Step 1:** Make sure that the installation location is suitable for the dimensions of the system and the load-bearing capacity of the wall meets the requirements.

Unit: mm

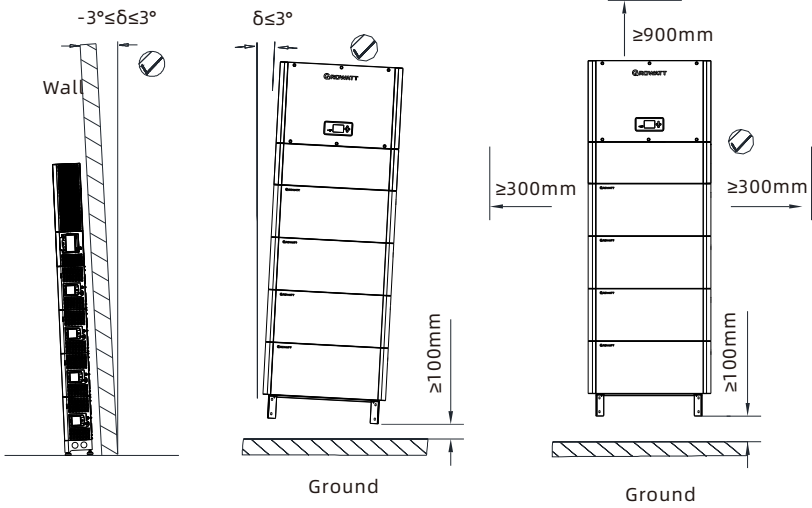

Figure 4. 14 Installation angle and clearances for wall-mounted installation

**Step 2: Assemble the wall mount bracket**

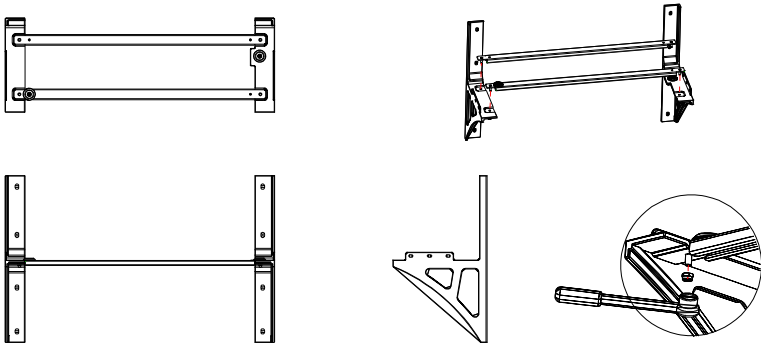

Figure 4. 15 Assemble the wall mount bracket

**Step 3:** Confirm the mounting position of the wall mount bracket, mark the hole positions and drill holes.

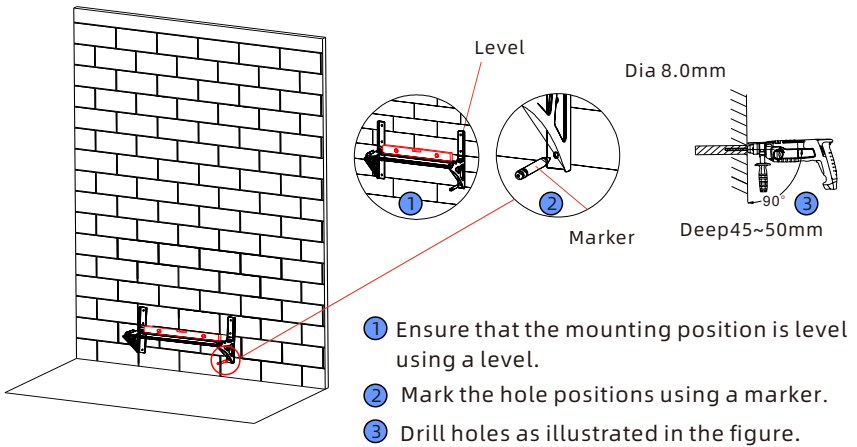
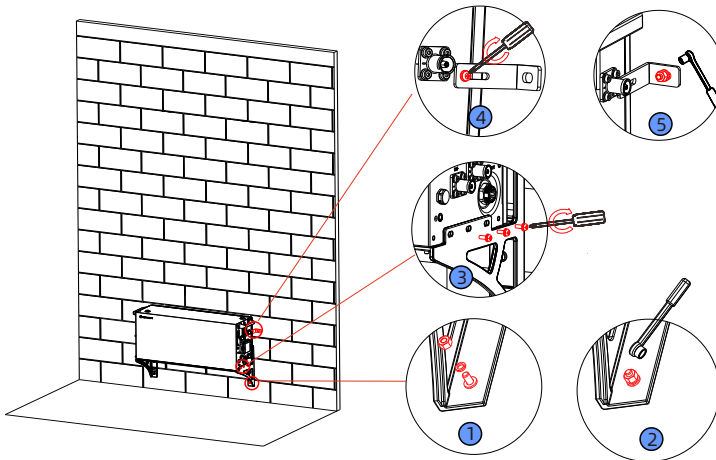

Figure 4. 16 Position for installing the bracket and drill holes

**Step 4:** Install the bracket and mark the hole positions to secure the first BM.



- 1
- 2 Fix the bracket to the wall using M6 expansion screws.
- 3 Fix the battery to the bracket using M4 screws.
- 4 Install anti tipping plates on the sides of the battery using M4 screws.
- 5 Mark the punching position of the anti tipping on the wall.

Figure 4. 17 Install the bracket and mark the hole positions to secure the first BM

**Step 5:** Mark all hole positions with the paper drilling template and drill holes.

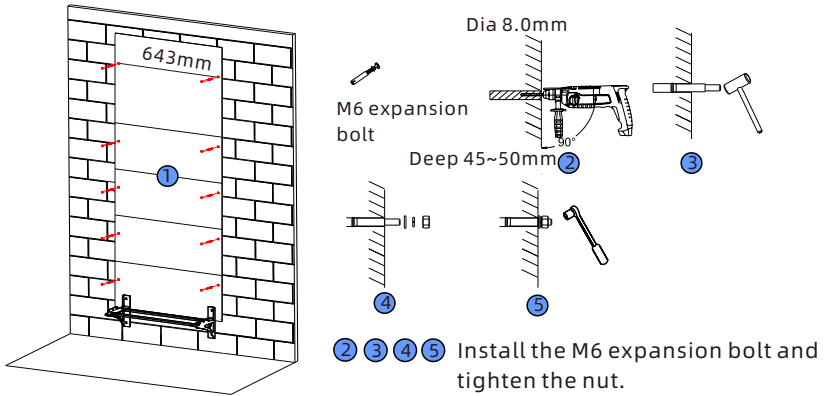

① Remove the battery, mark the hole positions to install the batteries.

Figure 4. 18 Hole positions and drill holes

Unit: mm

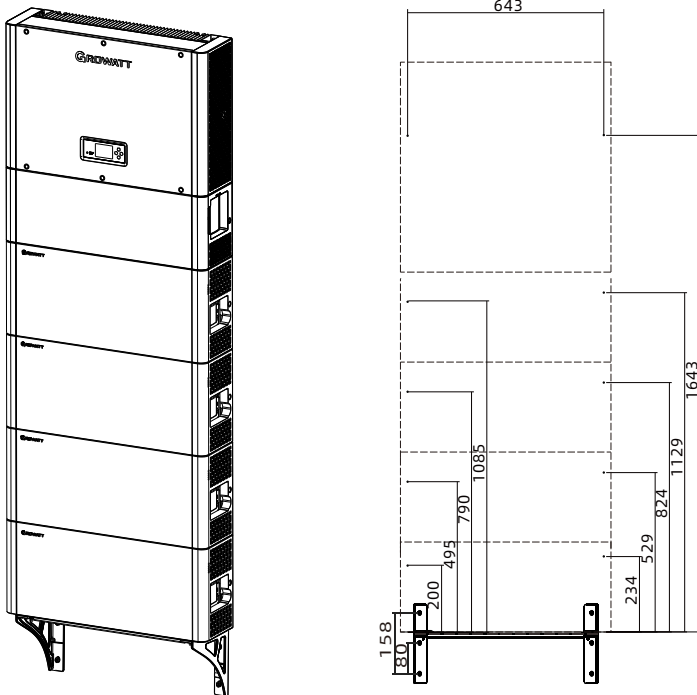
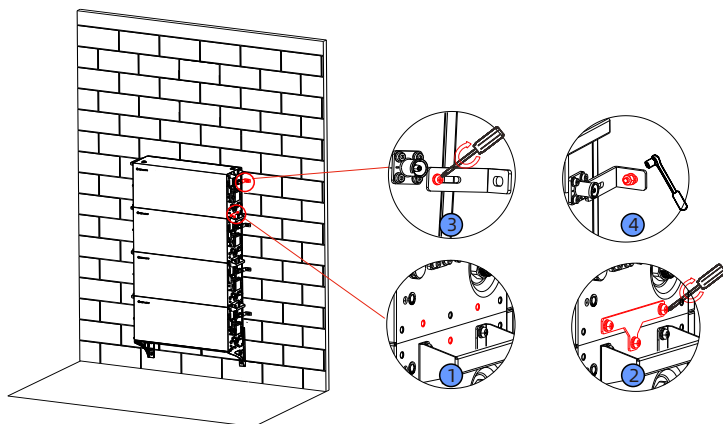

Figure 4. 19 Dimensions of the drilling template

**Step 6:** Install and secure the BMs in turn.



- ① ② Secure the connecting pieces on the both sides of the battery mouldle using the M4 screws, and tighten the 6 screws.
- ③ Install the connecting pieces on both sides and tighten the 2 screws.
- ④ Install the anti-tipping plates on bothsides to fix the modules to the wall.

Figure 4. 20 Install all BMs

**Step 7:** Install the die cast bracket and the inverter.

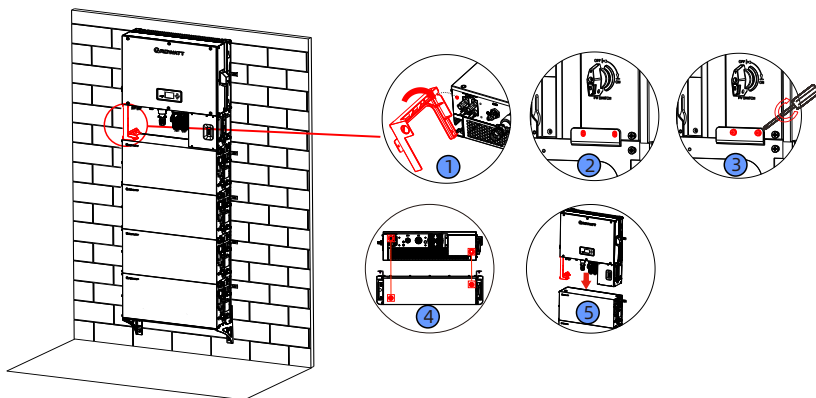

- ① ② ③ Install the die cast bracket on the left side of the inverter using M4 screws.
- ④ ⑤ When installing inverter, please note that the bottom depression of the inverter aligns with the protrusion of the battery.

Figure 4. 21 Install the SPH inverter

**Step 8:** Secure the inverter and install the decorative cover.

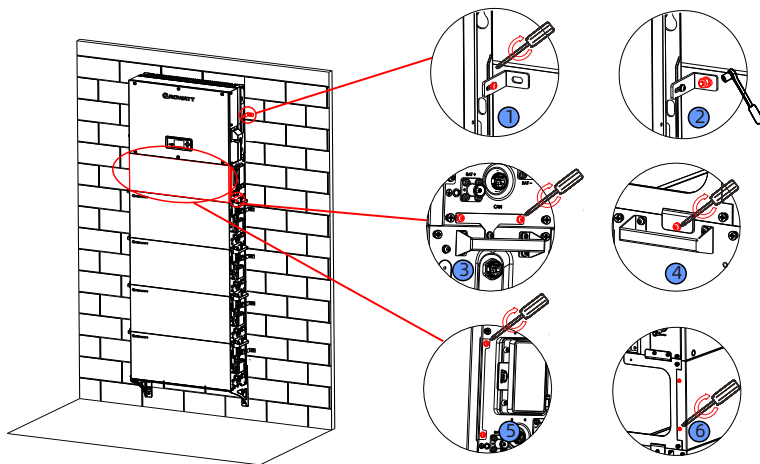

- ① ② Fix the anti tipping component to the inverter and wall using M4 screws and expansion screws respectively.
- ③ Install the connecting piece between inverter and battery using M4 screws.
- ④ Fix the inverter die-casting bracket to the battery using M4 screws.
- ⑤ ⑥ Install the inverter front panel and secure it with M4 screws.

Figure 4. 22 Secure the inverter and install the decorative cover

## 4.4 Electrical Connection



**WARNING**

Do not forget to wear the ESD wrist strap, safety gloves and goggles

### 4.4.1 Communication Terminal Wiring between BMs/between BM and SPH

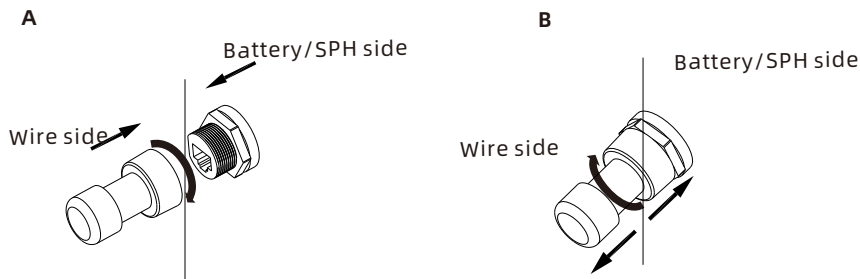

Figure 4.23 Communication terminal wiring between BMs/between BM and SPH

**Note:**

Figure A illustrates the installation of the communication terminal; Figure B illustrates the removal of the communication terminal.

**4.4 .2 Power Terminal Wiring between BMs/between BM and SPH**

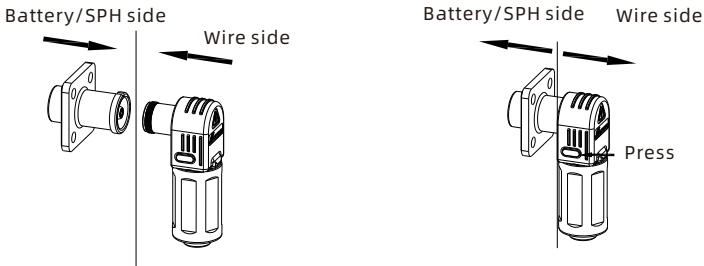

Figure 4. 24 Power terminal wiring between BMs/between BM and SPH

**Note:**

1. The positive terminal of the battery should be connected to the positive terminal of the SPH, and the negative terminal of the battery should be connected to the negative terminal of the SPH.
2. Please be sure to distinguish the positive and negative polarity when connecting the battery terminals. The SPH does not come with the reverse polarity protection. Incorrect battery wiring might damage the inverter.
3. After connecting the battery cables, it is necessary to install the decorative cover and secure it with screws. This way, the battery terminals are anti-tamper. For instructions on installing the decorative cover, please refer to Section 4.5.

**4.4 .3 EPS Connector Wiring Instructions**

**4.4 .3.1 Remove the EPS Connector**

The EPS connector has been pre-installed on the SPH inverter. If you do not need to connect to EPS loads, do not remove the EPS connector to avoid electric shocks due to accidental contact.

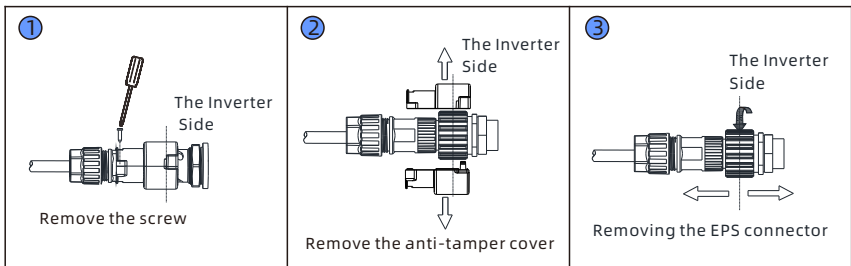

Figure 4. 25 Remove the EPS connector

- Step 1:** Loosen the screws on both sides of the anti-tamper cover.
- Step 2:** Remove the anti-tamper cover.
- Step 3:** Rotate the EPS connector to remove it from the inverter and pull it out.

**4.4 .3.2 Install the EPS Connector**

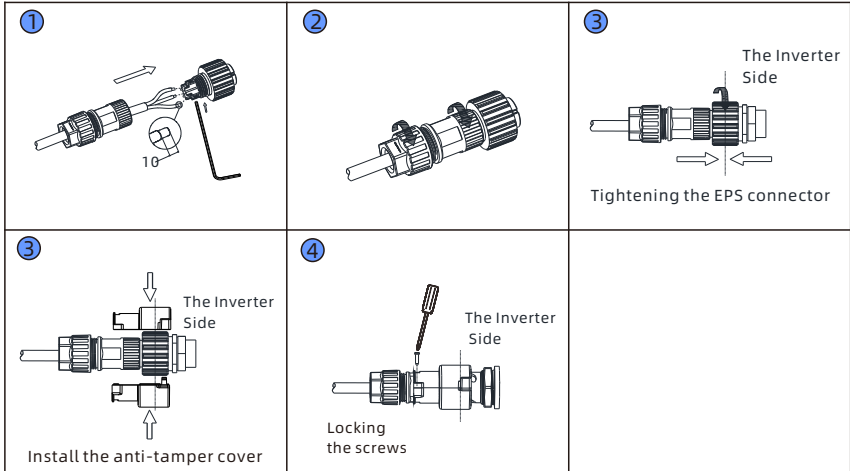

Figure 4. 26 Install the EPS connector

- Step 1.** Pass the stripped cable through the locking nut, sealing ring, and threaded sleeve in sequence. Insert the cable into the terminal block according to the polarity indicated on the terminal block. After tightening the screw, give the cable a gentle tug and it should not come loose to ensure a secure connection.
- Step 2.** Push the threaded sleeve into the socket and tighten the cap on the terminal.
- Step 3.** Finally, screw the threaded sleeve into the connection terminal on the inverter until both are tightly locked on the inverter.
- Step 4.** Put the anti-tamper cover on the connection terminal and tighten the buckle.
- Step 5.** Tighten the screws on both sides of the anti-tamper cover.



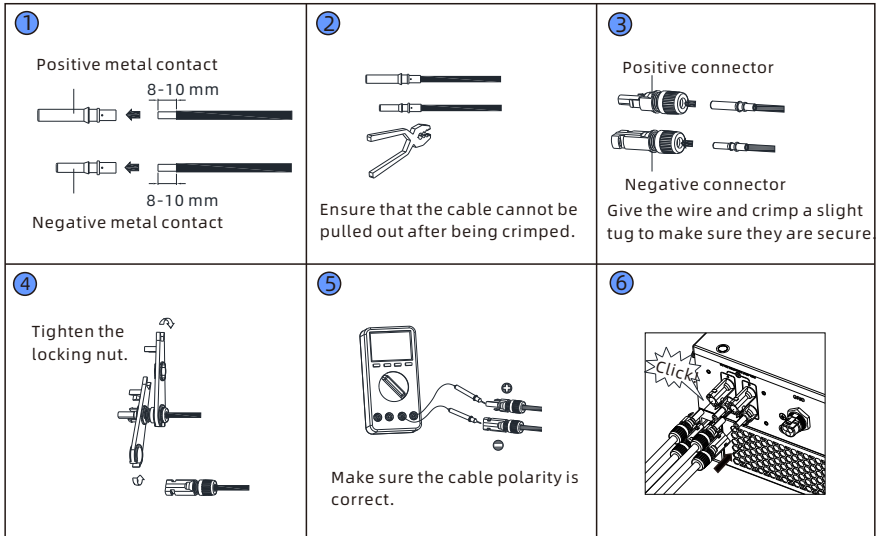

Figure 4. 31 Install the PV connectors

**Step 1:** Insert the stripped cables into the positive and negative metal contacts respectively.

**Step 2:** Crimp the metal contacts and the cables with a crimping plier.

**Step 3:** Loosen the locking nuts from the connectors, then insert the positive and negative metal contacts into the connectors.

**Step 4:** Tighten the nuts of the connectors.

**Step 5:** Use a multimeter to ensure the correct polarity of the PV wiring.

**Step 6:** Insert the PV connectors into the PV connection terminal of the SPH.

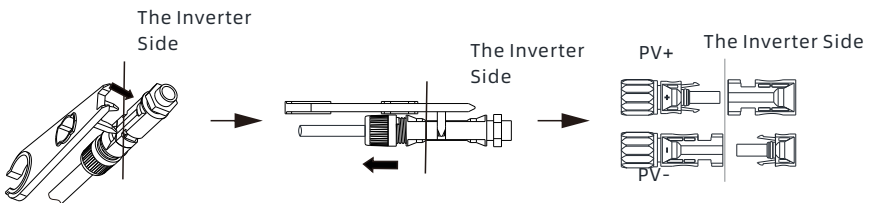



Figure 4. 32 Remove the PV connectors

**Step 1:** Insert an open-end wrench into the notch and press the wrench with an appropriate force.



**Step 2:** Pull out the PV connector.

 <p><b>WARNING</b></p>	<p>The solar modules connected to the inverter must comply with IEC 61730 Class A requirements. Please use the same brand of male and female photovoltaic connectors.</p>
---	---

The SPH single-phase inverter has 2 independent inputs: MPPT1 and MPPT2.

**Note:**

1. PV connectors come in pairs (male and female connectors).
2. The SPH single-phase inverter has two independent inputs: MPPT1 and MPPT2. The same photovoltaic output can be connected to MPPT1 and MPPT2 at the same time, or each MPPT can be separately connected to a photovoltaic panel output end, which can be selected according to actual needs.

 <b>CAUTION</b>	<p>The DC input of the inverter shall not exceed the following limits:</p> <table border="1" data-bbox="253 443 953 536"> <thead> <tr> <th data-bbox="253 443 517 488">Types</th> <th data-bbox="517 443 729 488">Max current MPPT1</th> <th data-bbox="729 443 953 488">Max current MPPT2</th> </tr> </thead> <tbody> <tr> <td data-bbox="253 488 517 536">SPH 3000-6000TL-HUB</td> <td data-bbox="517 488 729 536">16A</td> <td data-bbox="729 488 953 536">16A</td> </tr> </tbody> </table>	Types	Max current MPPT1	Max current MPPT2	SPH 3000-6000TL-HUB	16A	16A
Types	Max current MPPT1	Max current MPPT2					
SPH 3000-6000TL-HUB	16A	16A					
 <b>DANGER</b>	<p>High voltages are dangerous!          The PV array generates DC voltage to the inverter when exposed to sunlight. Before connecting the PV array, ensure that the DC switch and AC circuit breaker are disconnected from the inverter. Do not connect or disconnect DC connectors on load. Ensure that the maximum open-circuit voltage (Voc) of each PV string is less than the maximum input voltage of the inverter. Check the design of the photovoltaic plant. When the solar panel temperature is -15 °C, the maximum open-circuit voltage shall not exceed the maximum input voltage of Inverter.</p>						
 <b>CAUTION</b>	<ul style="list-style-type: none"> <li>➤ Improper operation may cause fatal injury to the operator or irreparable damage to the inverter. Please do the wiring work with experienced help.</li> <li>➤ Do not ground the positive and negative terminals of the photovoltaic array; otherwise, the inverter may be seriously damaged.</li> <li>➤ Check whether the cable polarity of the photovoltaic module is correct. The input voltage of the inverter should not exceed the maximum voltage.</li> <li>➤ Photovoltaic module grounding: The SPH is a transformerless inverter, so it has no electrical isolation. Do not ground the DC circuit of the PV module connected to the SPH. If a grounded PV module is connected to the SPH, the error message PV ISO Low is displayed.</li> <li>➤ The grounding of photovoltaic modules and photovoltaic generators must meet local grounding requirements. GROWATT recommends connecting the generator frame and other conductive surfaces to ensure continuous conduction to the ground for optimal protection of systems and personnel.</li> <li>➤ Turn off the PV DC switch when maintaining the inverter.</li> </ul>						

#### 4.4.4 Grid Connector Wiring Instruction

##### 4.4.4.1 Install the Grid Connector

Take the following parts from the accessory bag:

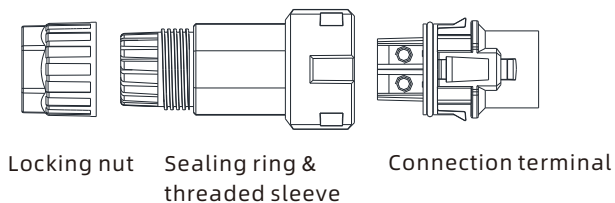

Figure 4.27 Grid connector

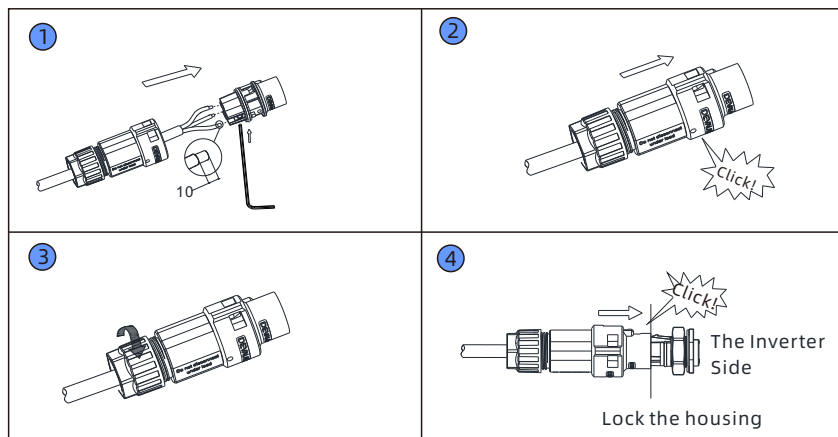

Figure 4.28 Install the Grid connector

**Step 1.** Pass the stripped cable through the locking nut, sealing ring, and threaded sleeve in sequence, insert the cable into the terminal according to the polarity indicated on the terminal, and tighten the screws.

**Step 2.** Push the threaded sleeve into the socket

**Step 3.** Tighten the locking nut on the terminal.

**Step 4.** Finally push the threaded sleeve into the connection terminal until both are tightly locked on the inverter.

**Note:**

After the Grid connector is installed, a screwdriver is required if you need to remove it, which is shown in Figure 39.

#### 4.4.4.2 Remove the Grid Connector

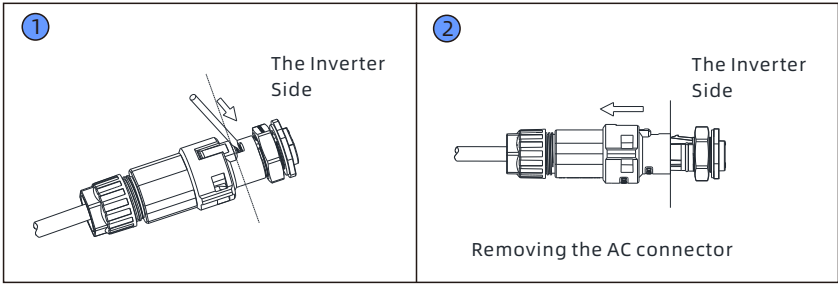

Figure 4. 29 Remove the Grid connector

**Step 1:** Press the buckle out of the slot using a small screwdriver.

**Step 2:** Unplug the AC grid connector.

#### 4.4.5 AC-side Cable Specification Recommendation

Conductor cross section	Max cable length					
	3000	3600	4000	4600	5000	6000
5.2mm <sup>2</sup> 10AWG	40m	33m	28m	26m	25m	23m
6.6mm <sup>2</sup> 9AWG	50m	42m	36m	33m	32m	29m

#### 4.4.6 PV Connector Wiring Instructions

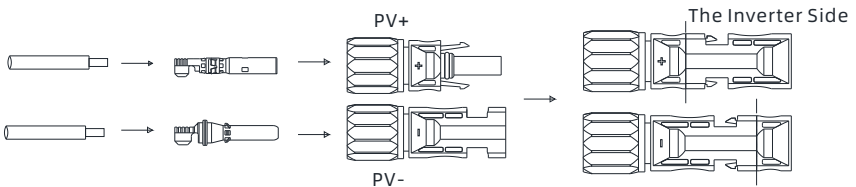

Figure 4. 30 PV connectors

Connect the PV input cables with the VP-D4 PV connectors. The procedure is as follows:

1. Turn off the PV switch.
2. Insert the positive and negative cables of the PV panel into the VP-D4 connectors, then connect the positive (+) of the connecting cable to the positive (+) of the PV input connector, and connect the negative (-) of the connecting cable to the negative (-) of the PV input connector, noting that the PV input voltage and current should be within the permitted range:

Max MPPT work voltage : 560V (considering the minimum temperature)

Maximum PV input current :16A/MPPT

Maximum PV input power per string :6000W

**Note:**

1. Cables  $\geq 4\text{mm}^2$ / 12 AWG are recommended.
2. Do not connect to other DC power supply other than the PV panels.

**4.4 .7 Datalogger Installation Instructions**

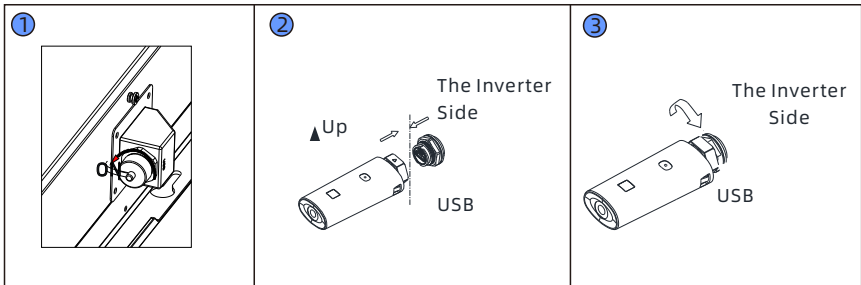

Figure 4. 33 Install the datalogger

Follow the installation steps:

1. Remove the waterproof cover from the USB port.
2. Plug in the datalogger.
3. Secure the datalogger.

4.4 .8 System Wiring  
4.4 .8.1 System Wiring

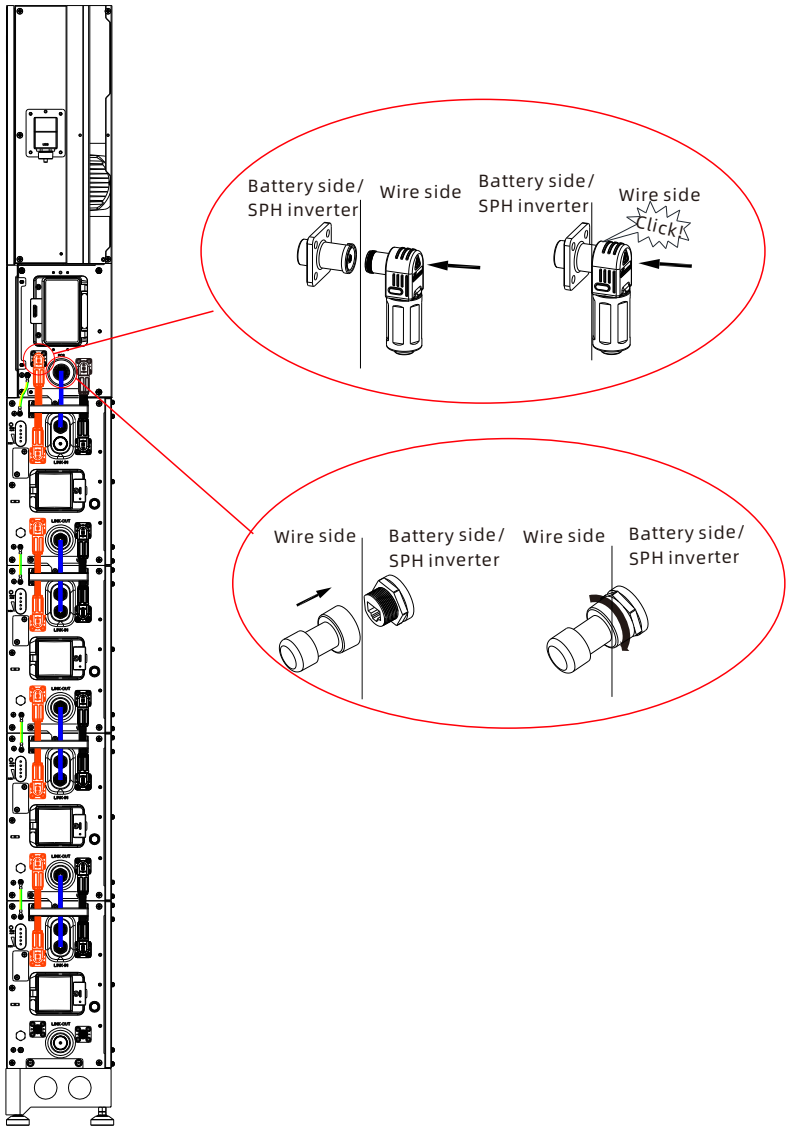

Figure 4. 34 Single-column system wiring diagram

**Note:**

1. The battery is not allowed to be installed while it is running. Before installation, the battery module circuit breaker should be disconnected and all indicator lights should be off.
2. Connect the battery power cables: Take out the positive and negative power cables from the accessory bag delivered with the battery package. Start from inserting into the inverter terminals, and connect them in parallel from top to bottom; pay attention to distinguish the positive and negative terminals, the orange terminals and wires correspond to the positive pole, the black terminal and wire correspond to the negative pole;
3. Connect the communication cables between BMs: Take out the communication cables from the accessory bag. Start from connecting the inverter network port to the PCS (silk screen) network port of the top BM. Then connect the LINK-OUT network port of the top BM to the LINK-IN network port of the second BM, and so on for other BMs;
4. Take out the PE cables and M4 screws from the accessory bag. Connect the PE cables, starting from the ground point of the inverter, and then connect the PE cables of the BMs downwards;

**Note:**

The plastic decorative cover should be installed and secured with screws so that the battery wiring can only be disconnected with the help of tools as required.

#### 4.4 .8.2 Dual-column system wiring diagram

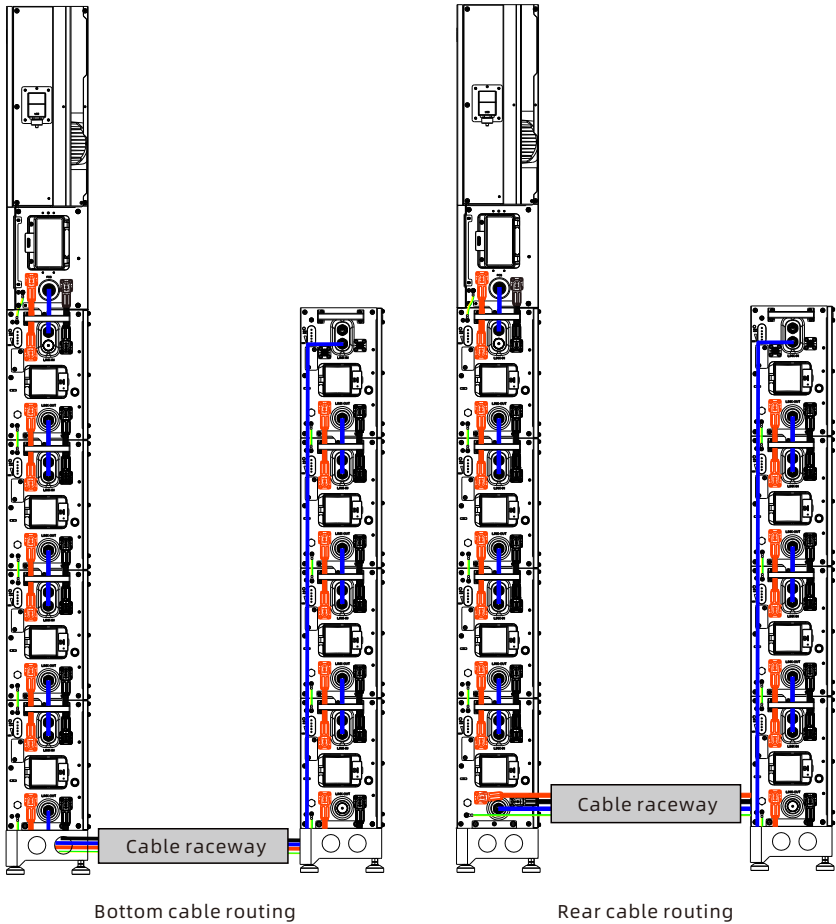

Figure 4. 35 Dual-column system wiring diagram

**Note:**

1. When installing the battery system in two columns, you can choose bottom cable routing by threading cables through the battery base the and cable raceway or the rear cable routing by installing a cable raceway on the wall directly as indicated in the figure above.
2. The LINK-OUT network port of the BM at the bottom of the first column must be connected to the LINK-IN network port of the BM at the top of the second column; otherwise communication cannot be established.



## 4.4.9 External Communication Port Installation

### 4.4.9.1 External communication port description

The SPH inverter has a total of 8 external communication ports. The appearance of the ports is shown in Figure 46. Each port contains 8 pins.

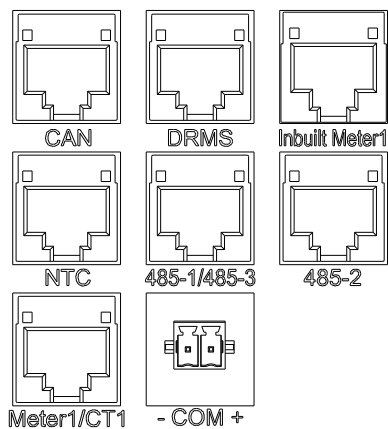

Figure 4.36 Communication ports

PIN definition of the ports

	P1		P2		P2	
Silk screen	CAN		DRMS		Built-in Meter	
Pin	Definition	Describe	Definition	Describe	Definition	Describe
1	/	NT (Not Connected)	DRM1/5	DRM	/	NT
2	/	NT	DRM2/6	DRM	/	NT
3	/	NT	DRM3/7	DRM	CT2+	CT2 positive pole
4	CAN_H	H of CAN	DRM4/8	DRM	CT1+	CT1 positive pole
5	CAN_L	L of CAN	REF	DRM	CT1-	CT1 negative electrode
6	GND.S	NT	COM	DRM	CT2-	CT2 negative electrode
7	GND.S	Battery wake-up ground	PIN7-PIN8 shorting	NT	/	/
8	WAKE.UP	Battery wake-up positive	PIN7-PIN8 shorting	NT	/	/

	P4		P5		P6	
Silk screen	NTC		485-1/485-3		485-2	
Pin	Definition	Describe	Definition	Describe	Definition	Describe
1	GND S	Ntc-	485-1_B		485-1_B	
2	GND S	Ntc-	GND S		GND S	
3	GND S	Ntc-	/		/	
4	GND S	Ntc-	485-1_B		485-1_B	
5	NTC	Ntc+	485-1_A		485-1_A	
6	NTC	ntc+	/		/	
7	NTC	ntc+	485-3_B		/	
8	NTC	ntc+	485-3_A		/	

	P7		P8	
Silk screen	Meter1/CT1		COM port	
Pin	Definition	Describe	Definition	Describe
1	RS485_B	Rs485 B	COM-	COM port negative
2	CT1_Pin2	CT positive	COM+	COM port positive
3	CT1_Pin2	CT positive	/	/
4	RS485_B	Rs485 B	/	/
5	RS485_A	Rs485 A	/	/
6	CT_Check	Wire breakage detection	/	/
7	GND S	Grounding	/	/
8	Ct1_Pin1	CT negative	/	/

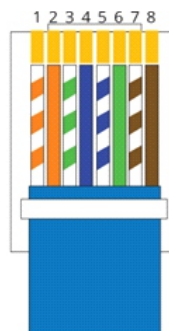

LAN 1-8 color code  
Pin 1: White/Orange  
Pin 2: Orange  
Pin 3: White/Green  
Pin 4: Blue  
Pin 5: White/Blue  
Pin 6: Green  
Pin 7: White/Brown  
Pin 8: Brown

### 4.4 .9.2 External Communication Terminal

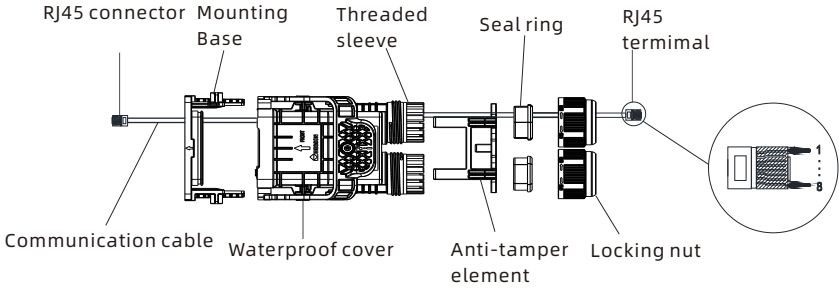
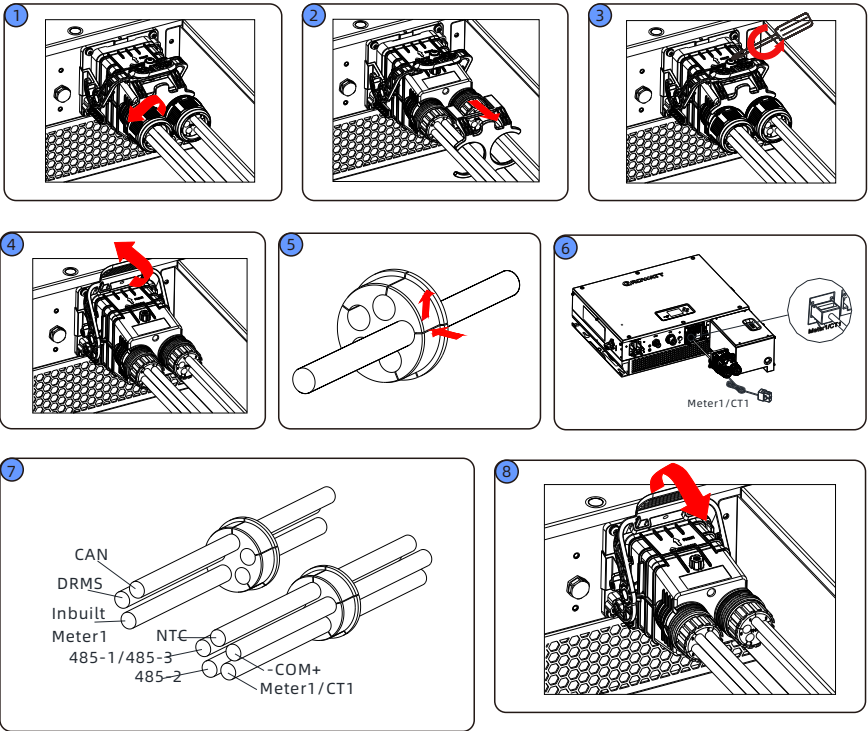
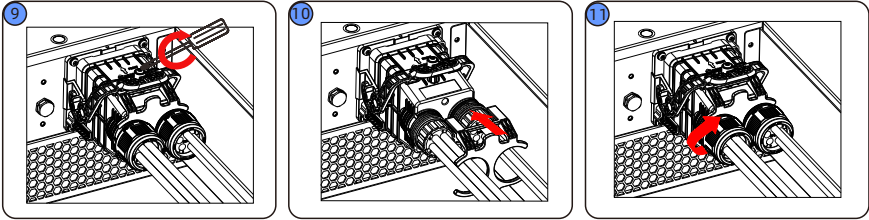

Figure 4. 37 Communication terminal

### 4.4 .9.3 External Communication Terminal Installation Instructions





- ① Unscrew the two swivel nuts from the waterproof cover by turning them counterclockwise.
- ② Remove the anti-tamper element.
- ③ Loosen the screws on the snap handle.
- ④ Turn the handle toward the inverter to remove the waterproof cover.
- ⑤ Thread the external communication cable through the swivel nut, cable support sleeve and waterproof cover in turn.
- ⑥ Connect the RJ45 connector with the communication cable and plug it into the corresponding communication port on the inverter.
- ⑦ Connect all communication cables as required following Steps 4-5.
- ⑧ Align the waterproof cover with the locating pins on the base and insert it into the mounting base. Secure the snap handle by turning it in the opposite direction.
- ⑨ Secure the screws on the handle.
- ⑩ Install the anti-tamper element.
- ⑪ Plug the empty support sleeve with the waterproof plug and tighten the swivel nut clockwise.

Figure 4. 38 Install the communication terminal

#### 4.4 .9.4 External Communication Port Functions and Settings Instructions

##### A. CAN Communication Port

1. If a lead-acid battery is used, you do not need to install this communication cable.
2. CAN battery communication and 485-2 battery communication cannot be installed simultaneously. Please choose the correct communication method according to the battery manual.
3. If the "485-2" communication cable or "CAN" communication cable is not used, do not remove the filler plug from the cable support sleeve.

##### B. DRMS communication port

PIN	Simultaneous charging and discharging capacity
1	DRM1/5
2	DRM2/6
3	DRM3/7
4	DRM4/8
5	REF
6	COM
7	Shorting to PIN8
8	Shorting to PIN7

#### DEMAND RESPONSE MODES (DRMS)

Mode	Requirement
DRM0	Operate the disconnection device
DRM1	Do not consume power
DRM2	Do not consume at more than 50% of rated power
DRM3	Do not consume at more than 75% of rated power AND Source reactive power if capable
DRM4	Increase power consumption (subject to constraints from other active DRMs)
DRM5	Do not generate power
DRM6	Do not generate at more than 50% of rated power
DRM7	Do not generate at more than 75% of rated power AND Sink reactive power if capable
DRM8	Increase power generation (subject to constraints from other active DRMs)

**Note:** If this port is not used, do not remove the filler plug from the cable support sleeve.

### C. Communication port of the built-in Meter 1

1. This communication port is used for data transmission with the CT for export limitation. In order to improve the sampling accuracy, the inverter is equipped with a built-in electric meter, and the CT working with the meter should be connected to the network port; only CTs provided by Growatt are supported.
2. Open the buckle of the CT, and you can see an arrow indicating the direction of the current flow. Clamp the CT on the grid connection line to be detected, and fasten the CT to complete the installation. The CT wiring is shown below:

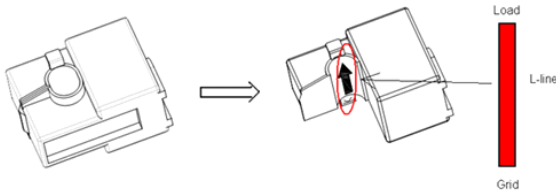

Figure 4. 39 Install the CT

### Note:

The direction of the arrow on the CT (from K to L) corresponds to the direction of current flow from the grid to the load in the live line. The sensor should be placed inside the distribution panel.

### D. NTC communication port

When the machine is equipped with lead-acid batteries, this interface is used for lead-acid battery temperature measurement. Australian machines use lithium batteries by default, and this port is not used by default.

### E. 485-1/485-3 communication port and 485-2 communication port

This port can be optionally used for establishing communication between SEM/VPP/METER2 and the upper computer. The SEM/METER2 should be purchased separately by the customer.

### F. METER1/CT1 communication port

1. This communication port is for connection to an external meter or external CT for export limitation. To enable this communication port, you need to set the working mode on the LCD screen. For details, please refer to Section 6.1.2.4.

2. Requirements on CT selection:

- (1) CT wire specifications: RJ45, standard LAN cable (with an 8P module plug on one end, and the other end connected to the transformer). The external CT wire for export limitation is recommended not to exceed 15 m.
- (2) If the built-in meter cannot meet the requirements or the CT wire of the built-in meter is not long enough, please select the external meter solution.
- (3) When using an external meter, you just need to connect the meter communication cable and insert it into the METER1 port. Generally, no additional settings are required.

(4) In Australia, it is generally not recommended to use a CT for export limitation. If needed, please consult after-sales service.

#### G. COM communication port

1. For unused cables such as the COM port cable, do not remove the filler plug from the cable support sleeve.
2. The COM port displayed below is a COM port signal port, and its port Settings are listed in the DRY connect function setting item on the display. The left pin next to the METER1/CT1 port is the negative pole, while the right pin is the positive pole. Please pay attention to the polarity when connecting the cable.
3. The COM port can provide a source of 12V and less than 200mA (Pin 1 - & Pin 2 +) to devices such as drivers and relays. Please note the output power of this power source.

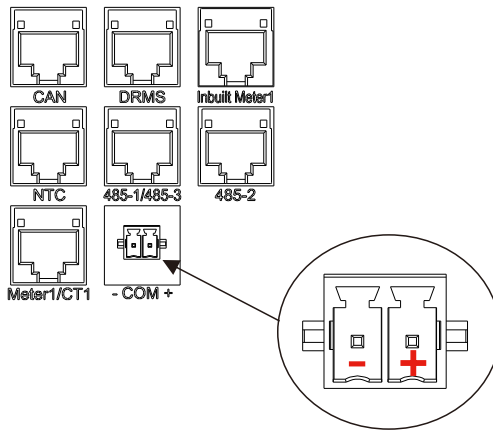

Figure 4. 40 COM communication port

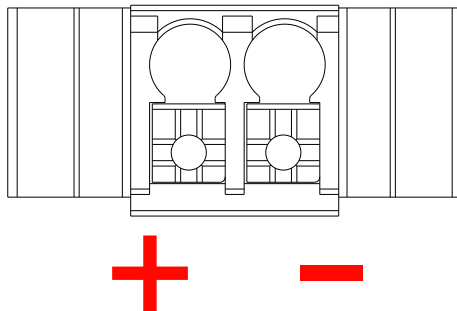

Figure 4. 41 Polarity of the COM port

#### 4.4.10 PE Cable Wiring Instructions

The SPH must be reliably grounded with the PE cable. The ground point is shown below. The minimum wire gauge of the PE cable is 10 AWG.

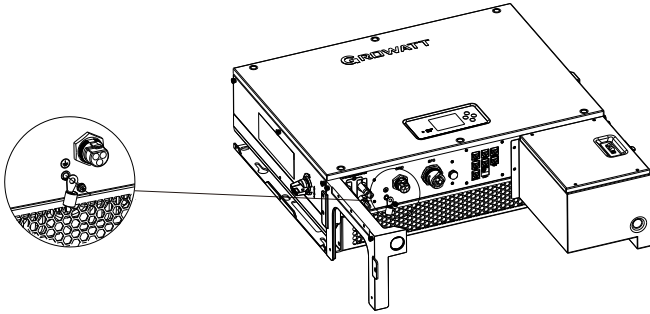

Figure 4. 42 PE cable wiring diagram

#### PV array grounding

The grounding conductor for the PV panel frame must be securely grounded on the PV array side, the inverter side, and the battery side. The cross-sectional area of the grounding conductor should be equal to that of the DC grounding conductor. The minimum wire gauge is 10 AWG.

#### DC grounding

Please select the DC grounding mode according to local standards, and select the PV grounding cables of the same specification.

#### Grounding device

If the positive or negative pole of the PV array in the PV system needs to be grounded, an isolation transformer should be used on the inverter output side for insulation. The isolation transformer must comply with IEC62109-1 and IEC62109-2 standards.

The wiring connection is shown below:

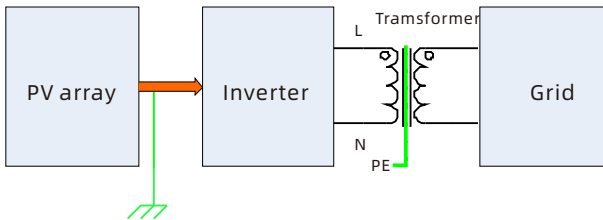

Figure 4. 43 PV array grounding diagram



### 4.4.11 System Wiring Instructions



**WARNING**

- The Growatt SPH 3000-6000TL-HUB is a single-phase inverter. If the inverter is installed in Australia or New Zealand, it must NOT be used as part of a three-phase combination.
- This inverter complies with IEC 62109-2 Clause 13.9 for ground fault alarm monitoring. In the event of a ground fault alarm, the inverter screen will display the fault code 'Error 303, NE Abnormal,' and the LED indicator would be red.

#### 4.4.11.1 Wiring Diagram A

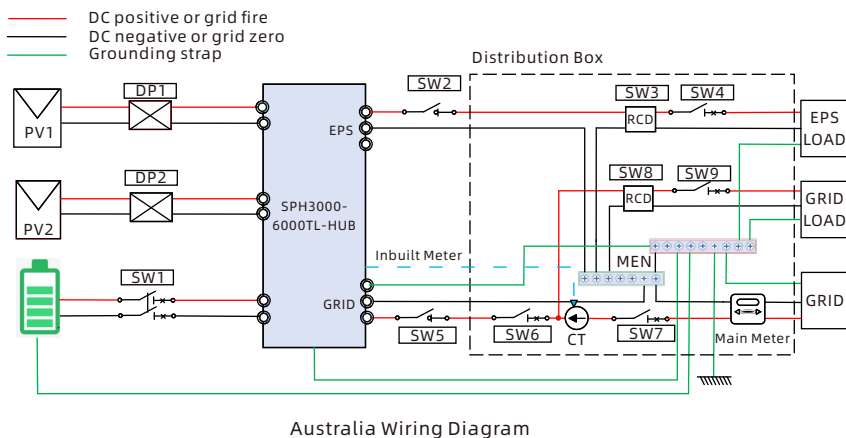

Figure 4. 44 Wiring diagram A

**Note:** Diagram A is the wiring diagram for regions such as Australia, New Zealand, and South Africa.

Switch type	Switch position	Switch selection
DC switch/ breaker	DP1/DP2	The inverter comes with a built-in PV input switch-disconnector compliant with requirements; follow local regulations to determine whether to install an external PV switch.
	SW1 (not required)	The inverter is equipped with the battery-side circuit breaker compliant with requirements; do not need to install an external one.

Switch type	Switch position	Switch selection
AC switch/breaker	SW5 (depends on on-site conditions)	Grid-side circuit breaker/switch-disconnector, to be installed close to the inverter side; recommended to install one when the distance between the inverter and the main distribution panel is greater than 3m or a blind spot exists between them; depends on the inverter capacity; recommended specification: $\leq 230\text{VAC}/35\text{A}$ .
	SW6 (mandatory)	Grid-side circuit breaker connected to the inverter, installed in the main distribution panel; follow local regulations to determine whether to install one; depends on the inverter capacity, recommended specification: $\leq 230\text{VAC}/35\text{A}$ .
AC breaker	Sw7 (mandatory)	Grid input main circuit breaker, installed in the main distribution panel; depends on the inverter capacity and the household load power.
	SW4/SW9 (mandatory)	Circuit breaker connected to loads, installed in customer's distribution panel; depends on the inverter capacity and the load power; recommended specification: $\leq 230\text{VAC}/35\text{A}$ .
	Sw2 (optional)	Off-grid output circuit breaker/switch-disconnector, to be installed close to the inverter side; not mandatory; depend on the inverter capacity and the load power; recommended specification: $\leq 230\text{VAC}/35\text{A}$ .
RCD	SW3/SW8 (mandatory)	Residual Current Device (RCD); recommended specifications: Type A, 30mA.

### 4.4.11.2 Wiring Diagram B

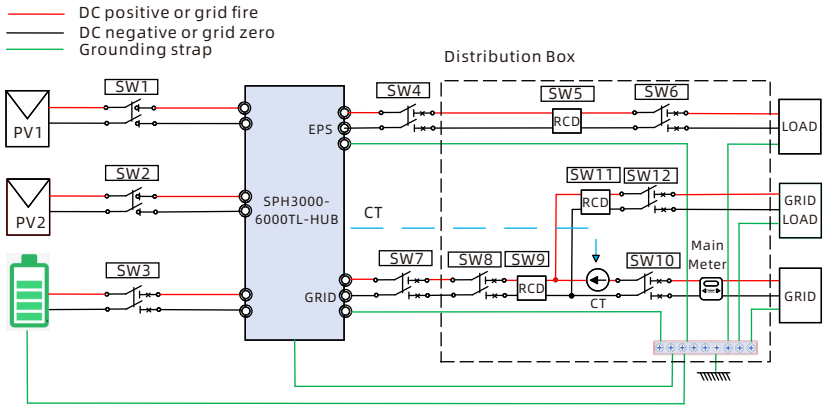

Wiring diagrams for other European countries

Figure 4. 45 Wiring diagram B

**Note:** Diagram B is the wiring diagram for European countries.

Switch type	Switch position	Switch selection
DC switch/ breaker	SW1/SW2	The inverter comes with a built-in PV input switch-disconnector compliant with requirements; follow local regulations to determine whether to install an external PV switch.
	SW3 (not required)	The inverter is equipped with the battery-side circuit breaker compliant with requirements; do not need to install an external one.
AC switch/breaker	SW7 (depends on on-site conditions)	Grid-side circuit breaker/switch-disconnector, to be installed close to the inverter side; recommended to install one when the distance between the inverter and the main distribution panel is greater than 3m or a blind spot exists between them; depends on the inverter capacity; recommended specification: $\leq 230\text{VAC}/35\text{A}$ .

Switch type	Switch position	Switch selection
AC switch/breaker	SW8 (mandatory)	Grid-side circuit breaker connected to the inverter, installed in the main distribution panel; follow local regulations to determine whether to install one; depends on the inverter capacity, recommended specification: $\leq 230\text{VAC}/35\text{A}$ .
	Sw10 (mandatory)	Grid input main circuit breaker, installed in the main distribution panel; depends on the inverter capacity and the household load power.
AC breaker	SW4 (optional)	Off-grid output circuit breaker/switch-disconnector, to be installed close to the inverter side; not mandatory; depend on the inverter capacity and the load power; recommended specification: $\leq 230\text{VAC}/35\text{A}$ .
	SW6/SW12 (mandatory)	Circuit breaker connected to loads, installed in customer's distribution panel; depends on the inverter capacity and the load power; recommended specification: $\leq 230\text{VAC}/35\text{A}$ .
RCD	SW5/SW11 (mandatory)	Residual Current Device (RCD); recommended specifications: Type A, 30mA
	SW9 (optional)	Type A RCD with a rating not less than 300mA.

### 4.4.11.3 Wiring Diagram C

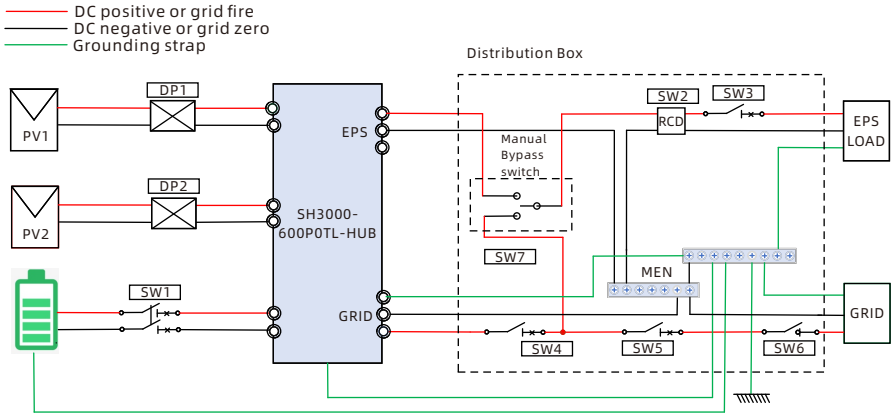

Australia Wiring Diagram

Figure 4. 46 Wiring diagram C

**Note:**

Diagram C is an example of a grid-connected energy storage system wiring. There are no special requirements for the cable connections.

Switch type	Switch position	Switch selection
DC switch/ breaker	DP1/DP2	The inverter comes with a built-in PV input switch-disconnector compliant with requirements; follow local regulations to determine whether to install an external PV switch.
	SW1 (not required)	The inverter is equipped with the battery-side circuit breaker compliant with requirements; do not need to install an external one.
AC switch/breaker	SW4 (mandatory)	Grid-side circuit breaker, installed in the distribution panel; depends on the inverter capacity and the load power, recommended specification: $\leq 230VAC/35A$ .
	SW5 (mandatory)	Grid-side circuit breaker, installed in the main distribution panel; depends on the inverter capacity, recommended specification: $\leq 230VAC/35A$ .

Switch type	Switch position	Switch selection
AC breaker	SW6 (optional)	Grid-side circuit breaker, installed in the main distribution panel; depends on the inverter capacity, recommended specification: $\leq 230\text{VAC}/35\text{A}$ .
	Sw3 (mandatory)	Off-grid output circuit breaker/switch-disconnector, installed in the main distribution panel; depend on the inverter capacity; recommended specification: $\leq 230\text{VAC}/35\text{A}$ .
RCD	Sw2 (mandatory)	Residual Current Device (RCD); recommended specifications: Type A, 30mA.
	Sw7 (optional)	Can be installed in the customer's main distribution box. During the maintenance period when the inverter fails, manually operate the switch to use the grid power to provide emergency power supply for EPS loads.



**WARNING**

**Note:**

For the connection modes in different regions, refer to the above three types of connection

The SPH's maximum on/off-grid transfer time is 15 ms. However, it CANNOT be used as an uninterruptible power supply (UPS) and is not applicable for critical scenarios such as medical power supplies. As shown in the diagram above, for maintenance purposes, add the SW7 at the EPS port and on the grid-connection side. You can select CLIPSAL's 4PS63CAM or Schneider's WATSNS63/1M manual disconnector switch. Install it in customer's distribution panel. When the inverter is damaged and failed to supply power to loads, you can manually operate the switch to use the grid power to provide emergency power supply for EPS loads.

**Note:**

After installing the Manual Bypass Switch,

- A. Ensure proper labeling on the distribution box. Otherwise, the EPS port may fail to supply power to the load due to incorrect operations.
- B. After the fault of the inverter is cleared, set the Manual Bypass Switch back to the EPS port position.



**WARNING**

- Please pay attention to the color of the connectors when connecting power cables. Only connectors with the same color can be connected.
- For safe operation of the system, it is necessary to ensure reliable grounding.
- This area is a restricted access area, which is explained as follows:
  - Area accessible only to electrically skilled persons and electrically instructed persons with proper authorization.
  - Note 1 to entry: An electrically skilled person is a person with relevant education and experience to enable him or her to perceive risks and to avoid hazards electricity can create.
  - Note 2 to entry: An electrically instructed person is a person adequately advised or supervised by electrically skilled persons to enable him or her to perceive risks and to avoid hazards which electricity can create.

### 4.5 Install the decorative cover

1. Remove the excess part from the decorative cover.

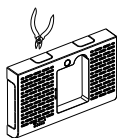

Top battery

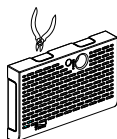

Bottom battery

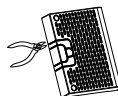
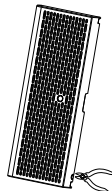
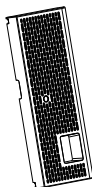

Handle the battery decorative cover

Handle the SPH decorative cover

Figure 4. 47 Handle the decorative cover

## 2. Install the decorative cover

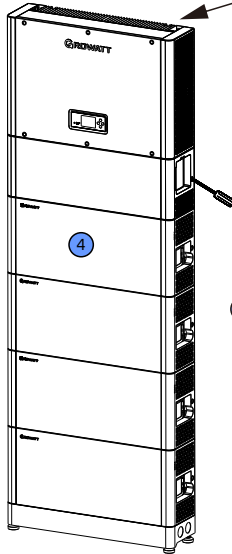
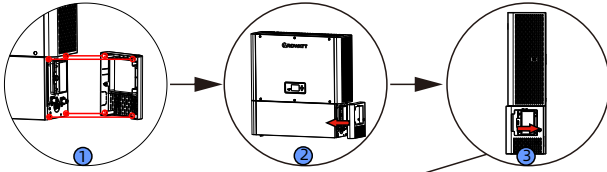

① ② ③ Insert the inverter-side stopper screw into the slot of the decorative cover.

④ Tighten the screws to secure the inverter decorative cover using a screwdriver, and secure the battery decorative cover with screws after installing it.

Figure 4. 48 Install the decorative cover



# 5 Power on and off the Battery System



**WARNING**

- Personnel who install and operate the SPH System must receive thorough training and possess the local national required qualifications before operation. Only qualified professionals and trained personnel are allowed to install, operate and maintain the equipment.
- Please stand on dry, insulating objects and do not wear conductive material such as watches and necklace during operation. Insulated tools should be used.
- Avoid contact with any parts with electric potential difference.
- Hang the warning sign: Do not touch. Authorized personnel only.
- If any abnormality is found when the equipment is energized, turn off the DC switch immediately. After the fault is rectified, turn on the switch again.

## 5.1 Power on the System

Step 1: Check if all cables are properly connected as required.

Step 2: Check if the PV and grid voltage are within the specified range.

Step 3: Turn on the breaker between the inverter and the grid, the breaker on the inverter's battery side, and the inverter's PV switch.

Step 4: If the inverter indicator is green and the battery indicator is blue, the system has been powered on successfully. When the cables are properly connected, the system would wake up the battery automatically. Therefore, you don't need to power on the battery.

### Note:

- a. Upon initial power-on of the SPH system, there will be a reminder to set up safety regulations. Please set the safety regulation options as prompted. Alternatively, you can manually enter the setting page after startup to modify the safety regulation options.
- b. Set the operating mode (mandatory) based on user's needs, such as Battery First, Grid First or Load First, and whether to disable export limitation when the PV power is sufficient.

## 5.2 Power off the System

Step 1: Press the button to power off the battery. The five LED indicators will blink three times. If multiple battery modules are connected in parallel, turning off any one of the BMs will shut down the entire battery system.

Step 2: Turn off the breaker between the inverter and the battery.

Step 3: Turn off the switch between the inverter and the PV panels.

Step 4: Turn off the breaker between the inverter and the grid.

## **5.3 Power on/off the battery system separately**

In case that the grid is not available, or when the battery needs to be connected to/disconnected from the system in operation, you might need to power on/off the battery system separately.

### **5.3.1 Power on the battery system**

Step 1: Ensure the battery system is properly connected to the inverter and turn on the battery circuit breaker.

Step 2: Press the battery power button for three to five seconds and observe the LED indicators on the panel. If the RUN/ALM and SOC indicators are on, it indicates that the battery system has been powered on successfully. If the RUN/ALM indicator is red, it indicates a fault. Troubleshoot the issue and then restart the equipment.

### **5.3.2 Power off the battery system**

Step 1: Press the battery power button for three to five seconds. The five LED indicators will blink three times and then turn off. If multiple battery modules are connected in parallel, turning off any one of the BMs will shut down the entire battery system.

Step 2: Turn off the circuit breaker between the battery and the inverter.

# 6 Commissioning and Maintenance

## 6.1 Preparation

### 6.1.1 Working Mode Description

#### 6.1.1.1 Normal Mode

Normal Mode indicates the normal operating state, including grid-connected mode and off-grid mode.

#### **Grid-connected Mode**

When the SPH operates in Grid-connected Mode, users can set appropriate working mode as needed. When configuring on the LCD screen with the buttons, you can only set the working mode for one time segment. When configuring on the website of the datalogger, you can configure the working mode for up to three time segments (for details, you can refer to Section 6.1.2.4).

1. **Load First:** Load First is the default mode. In this mode, PV energy is prioritized for supplying loads and the surplus solar power will be directed to charge the battery. The further excess power (if any) can be fed to the grid, subject to the Export Limitation settings. If PV energy is insufficient, the battery will discharge to power the loads. If the battery discharges to the user-defined discharge cutoff SOC, it will draw power from the grid to support the loads.
2. **Battery First:** In this mode, the PV power is sent to charge the battery first, suitable for periods of low electricity tariff. You need to set the start and end time for this mode, and the battery charging cutoff SOC. You can set power levels below the inverter's maximum charging power. If AC CHG (charge from grid) is disabled, the inverter will charge the battery with the PV power as much as possible, and send the surplus power to the loads. The further excess power will be exported to the grid based on the Export Limitation settings. If enabled, the inverter will charge the battery with the solar power first; if insufficient, it will draw power from the grid to support the loads.
3. **Grid First:** In this mode, PV energy will be primarily fed into the grid, suitable for periods with high electricity tariff. You need to set the start and end time for this mode, and the battery discharge cutoff SOC. Users can set power levels below the battery's maximum output power.

#### **Off-grid Mode**

If the grid power fails, the system will automatically switch to Off-grid Mode (you can disable this feature, referring to section 6.1.2.4), and output AC power with the solar and battery energy via the EPS port. If PV power is not available, then only the battery will discharge.

**Note:**

1. To ensure maximum efficiency and long-term stable operation of the inverter, it is recommended not to exceed 80% of the maximum power rating at the EPS port. For example, for a 6 kW model, it is recommended to connect a maximum load of 4.8 kW, meaning all loads combined should not exceed 4.8 kW when operating.
2. Only one time period can be set for the working mode on the LCD screen. To configure more time segments, please log in to the datalogger website.
3. If you want to charge the battery with power from the grid, you need to enable AC CHG on the SC interface, which requires to input the password. For details, please see Section 6.1.2.4.

**6.1.1.2 Fault Mode**

The intelligent control system of SPH continuously monitors and adjusts the system's status. If any unexpected situation is detected, such as system faults or device malfunctions, the LCD will display the fault information. In Fault Mode, the LED light will be red.

**Note:**

For detailed fault information, please refer to Section 8.1.

Some fault information is to remind users of potential faults on the inverter side.

**6.1.1.3 Upgrade Mode**

Upgrade Mode indicates that SPH is updating its software. During the update process, do not disconnect the power supply. After the update is complete, the SPH inverter will automatically restart and switch to another mode.

**6.1.1.4 Self-check Mode**

The SPH enters self-check mode before operating. If nothing abnormal is detected, the system will enter Normal Mode after completing the self-check. Otherwise, the system will enter Fault Mode.

**6.1.1.5 Standby Mode**

The SPH enters self-check mode before operating. If nothing abnormal is detected, the system will enter Normal Mode after completing the self-check. Otherwise, the system will enter Fault Mode.

### 6.1.1.6 Shutdown Mode

To shut down the SPH, all power sources must be disconnected, and the SPH inverter will automatically enter Shutdown Mode. The shutdown procedure is as follows:

1. Turn off the PV switch.
2. Turn off the battery-side breaker.
3. Turn off the grid-side breaker.
4. Press and hold the button of the battery system for 3 seconds to turn off the battery.

Afterwards, the LED and LCD on the inverter will be off, and the indicator on the battery module will go out.

#### Note:

After all actions are completed, you need to wait for more than 5 minutes until the internal voltage has discharged to a safe level.

## 6.1.2 LCD Screen and Button Description

### 6.1.2.1 Description of the LCD Screen

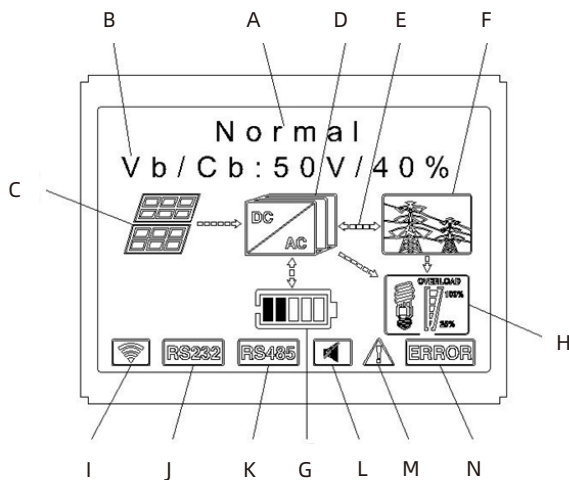

Figure 6. 1 LCD screen

Position	Description
A	Displays the operating status
B	Displays key information
C	PV Input (If connected to two PV inputs, it will display two; otherwise, it will display one)
D	SPH inverter
E	Power flow line indicator
F	Grid
G	Battery (displayed with five grids, each representing 20%)
H	Load output
I	Wireless communication
J	Rs232
K	Rs485
L	Buzzer (reserved)
M	Alarm info
N	Fault info

### 6.1.2.2 Description of the LED Indicator and Buttons

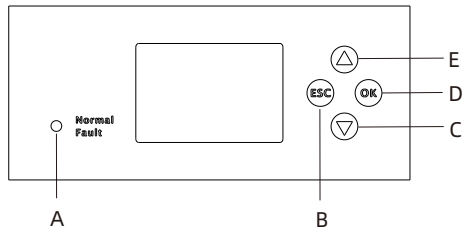

Figure 6. 2 LED indicator and buttons

Position	Description
A	LED indicator
B	ESC (cancel)
C	Down
D	OK
E	Up

**Note:**

The LED light indicates the status of SPH in two colors. Green indicates that the device is operating normally, while red indicates a malfunction or upgrade in progress. For details, please refer to Section 1.2.1.

**6.1.2.3 System Working Mode Settings**

Growatt products have been designed and tested according to the applicable international/regional standards. Upon receipt of the product, please set the corresponding safety regulations on the LCD screen based on your country/region.

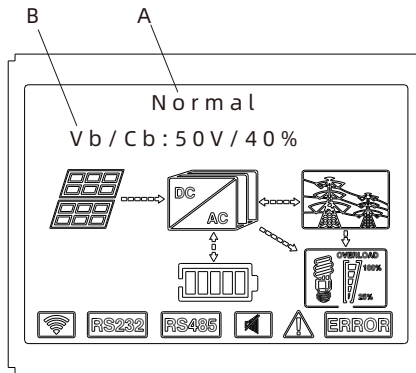

Figure 6. 3 Display of system operating status

**Line A:**

1. Standby Status: Indicates that the SPH is in Standby Mode. No inverter fault has been detected. It enters Standby Mode due to other reasons, such as the environment factor.
2. Normal Status: Indicates that the SPH is operating normally.
3. Checking Status: The SPH is performing self-check. If no error or warning is detected, it will switch to Normal or Standby Status. Otherwise, it will switch to Fault Status.
4. Programming Status: The SPH is updating its firmware.
5. Fault Status: A fault has occurred and the inverter stops operating for protection.

**Line B:**

**Note:** Generally, the pages will turn automatically. You can also manually turn the pages by pressing the "Up" button. The information sequence for the pages is as follows:

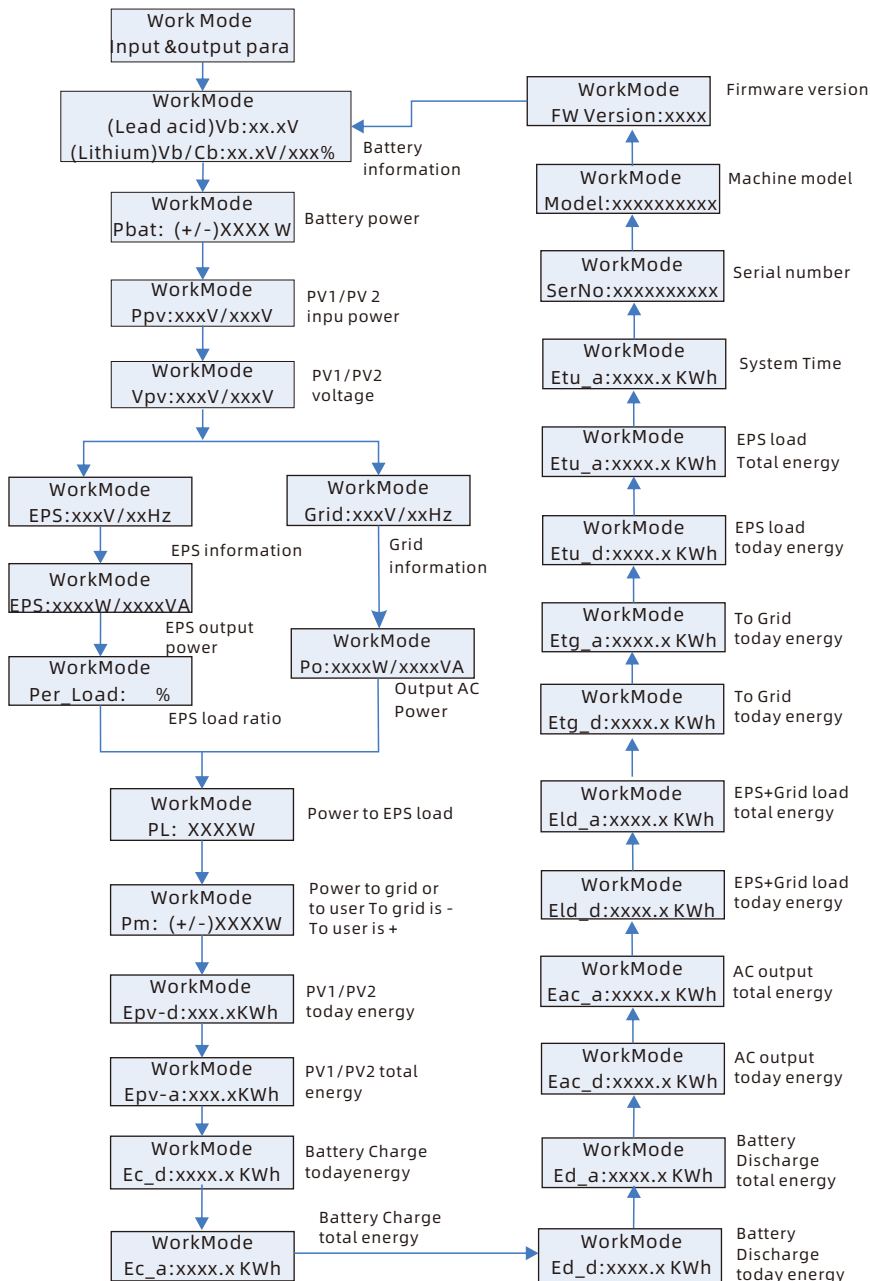

Figure 6. 4 Real-time display in a loop



**Note:**

1. Press "Down" to proceed (you can press "Up" to return to the previous page).
2. The working mode depends on the situation: If the SPH is in Normal Status, it will display "normal". If the SPH is in Standby Status, it will display "standby", and so on.
3. Special definitions: For example, Vb represents battery voltage. Cb represents the capacity of the lithium battery (this data is only displayed for lithium batteries). Pm represents user's monitoring power of the user.

**6.1.2.4 Working mode settings**

Press and hold the "OK" button for 3 seconds to enter the settings interface. View the settings options shown in the figure below with the "Up" and "Down" buttons. In the settings interface, press the "OK" button for 1 second to enter a settings option. Press the "ESC" button to exit a settings option.

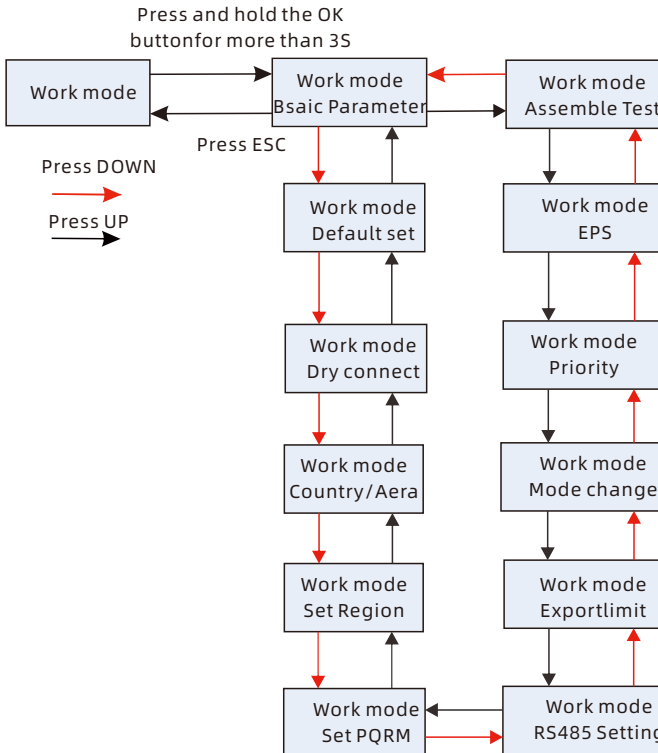

Figure 6. 5 Working mode settings

**Note:**

1. Press OK to select the specific setting item; press ESC to return to the previous settings page.
2. If you select the CEI standard and use the SPH inverter in Italy, the inverter comes with an auto-test function.

A. Under Basic Parameter, press and hold OK for 1 second, then you can see the following settings options:

Language: English, Italian, German

System Time

Lead-Acid Battery Charging Voltage: 58V (default)

Discharge Low Voltage: 48V (default)

Lead-Acid Constant Current: 25A (default)

RS485 Address

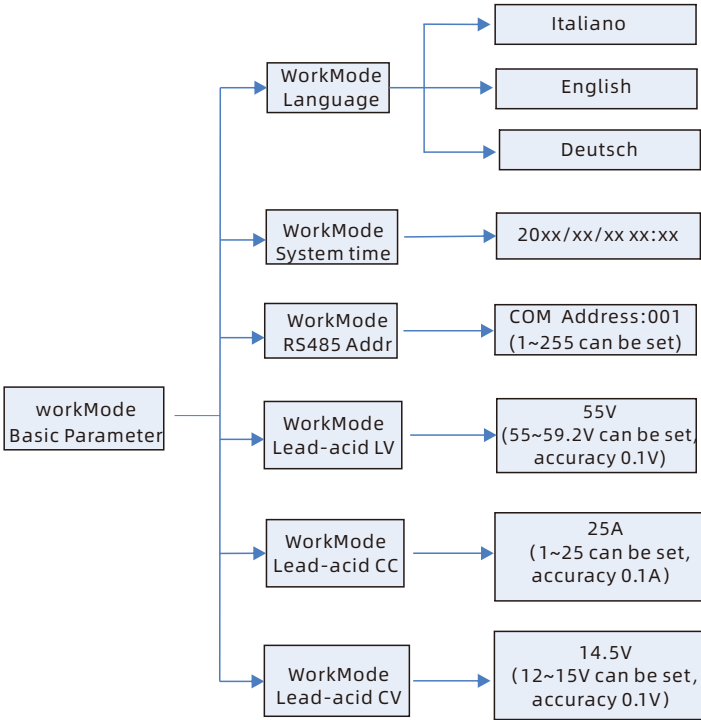

Figure 6. 6 Basic parameter settings

B. Under DEFAULT SET, press OK, then you can see the following option:

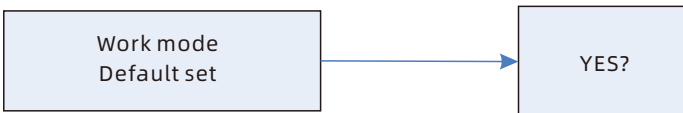

Figure 6. 7 Default setting

Growatt SPH Country/Area setting steps:

Country/Area	Model display	Country/Area	Model display
Australia	GT4XXXXXX3	Ausgrid	GT4XXXXXX6
Queensland	GT4XXXXXX2	Endeavour	GT4XXXXXX7
Victoria	GT4XXXXXX1	Ergon Energy	GT4XXXXXX8
	GT4XXXXXX4	Energex	GT4XXXXXX9
Horizon Power	GT4XXXXXX5	SA Network	GT4XXXXXXA
New Zealand	GT5XXXXXX8		

Step 1: Turn on the AC breaker between the SPH inverter and the grid.

Step 2: Turn on the grid switch of the SPH inverter (if a battery is connected, also turn on the battery switch; if no battery connected, only turn on the grid), and the inverter will start automatically.

Step 3: Ensure the inverter is successfully connected to the network and remains online in the ShinePhone APP.

 <b>WARNING</b>	<p>If energy quality and grid settings are selected during commissioning, these setting items should be locked and cannot be modified (unless otherwise authorized by Growatt)</p> <p>After completing energy quality and grid settings, verify compliance with safety regulations on the APP.</p> <p>After country settings are completed, select the correct energy quality response mode. If no country or region is selected, the inverter will run with Australia and Region A settings.</p>
---	---

#### E. Reset region

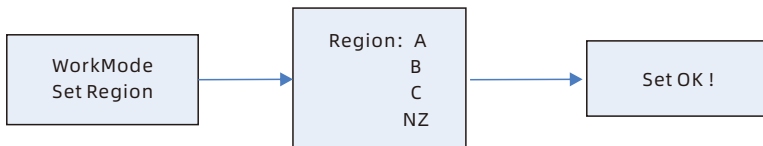

Figure 6. 11 Reset region

## F. Set PQRM

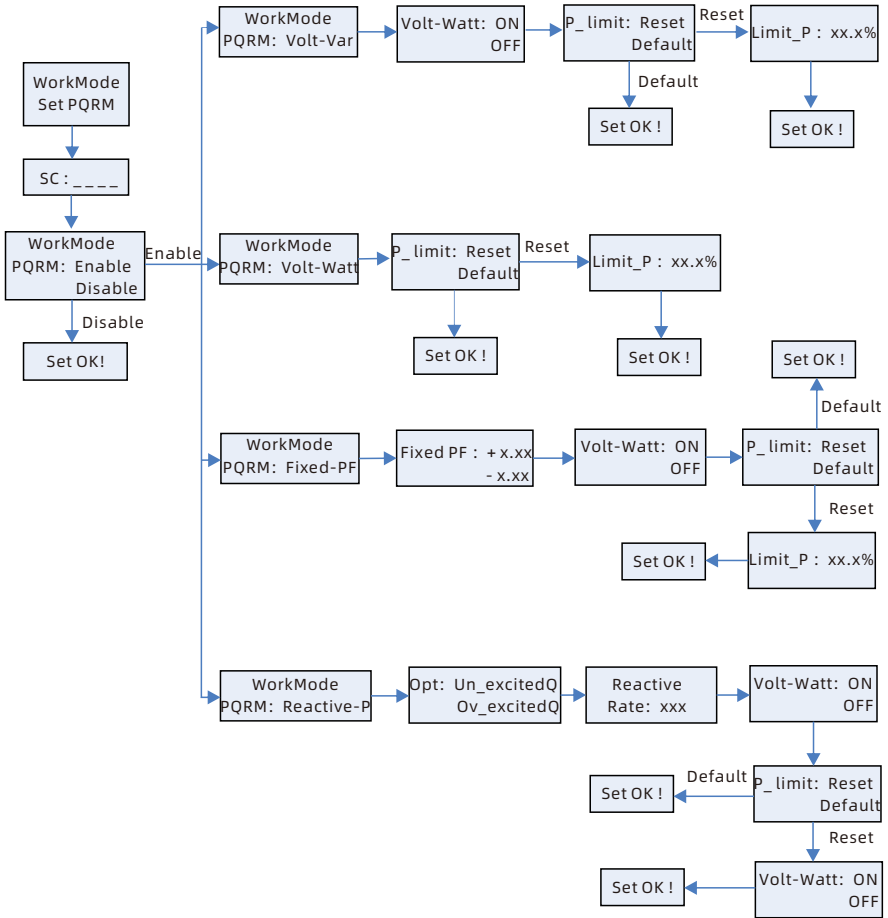

Figure 6. 12 PQRM settings

### Note:

If other values need to be set for DNSP other than the default values, please refer to Appendix to adjust the settings according to the regional default value instructions.

C. Under DRY connect, press OK, then you can see the following options:

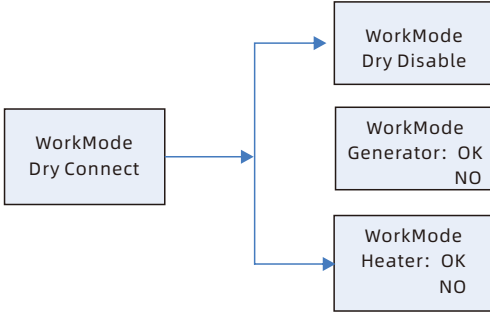

Figure 6. 8 DRY connect settings

D. Under COUNTRY/AREA, press OK, then you can set the country/area according to the safety regulations:

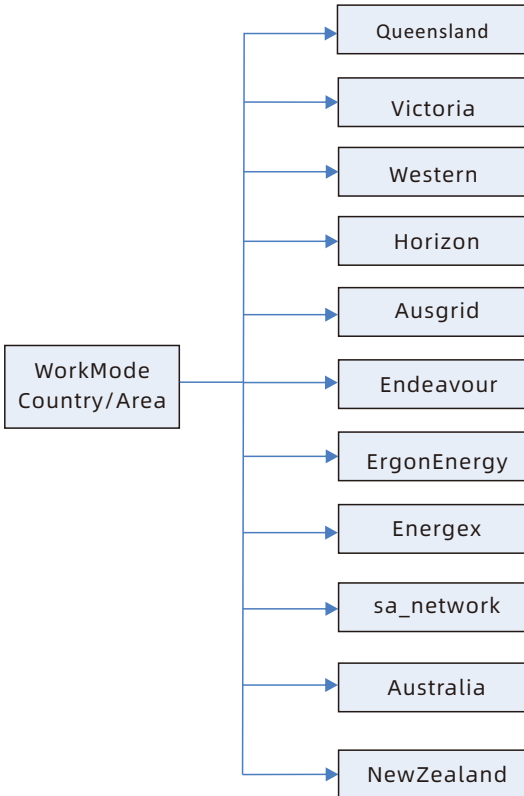

Figure 6. 9 COUNTRY/AREA

To modify the Country/Area, please follow the steps below:

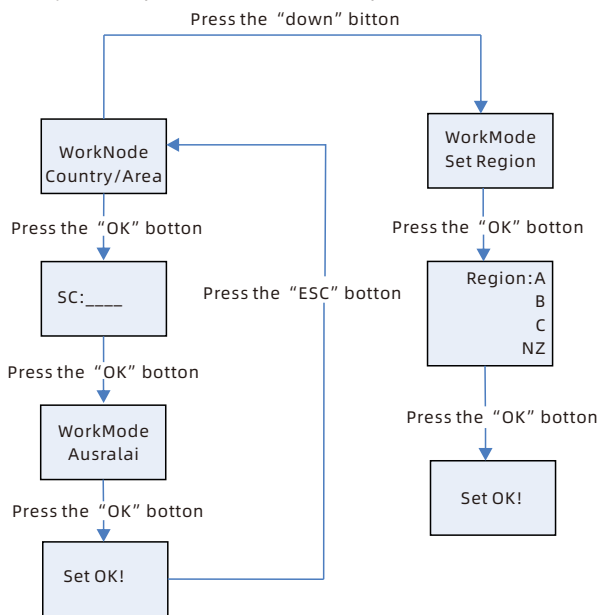



Figure 6. 10 COUNTRY/AREA settings

 <p><b>WARNING</b></p>	<p><b>Note:</b> When setting the national safety standards on the LCD, please turn off the PV switch and AC breaker, but keep the battery power on.</p>
	<p><b>Note:</b> Please calibrate the inverter's system time after start-up. If the country setting is incorrect, please turn off the inverter and re-set it.</p>

As of December 18th, 2021 all inverters installed in Australia must comply with requirements of AS/NZS 4777.2: 2020 and have one of the following 3 x default Regions selected upon commissioning:

1. Australia A
2. Australia B
3. Australia C

Based on CEC notification, SA power network, Horizon Power, Western Power, EnergyX, Ergon energy, Ausnet Services, Essential Energy, Jemena, Citipower, Powercor, Ausgrid and Endeavour will have their own settings. Please confirm with the relevant DNSP as to which region should be selected.

C. Under "Export Limit", press "OK", then you can see the following settings options:

You can adjust the Export Limitation parameter to control the power fed to the grid. If enabled, the power exported to the grid would be less than or equal to the pre-set value.

The Fault Safety Function is to ensure that if any part of the ELS fails, the active power output at the connection point will decrease to the pre-defined output capacity or less within the specified time.

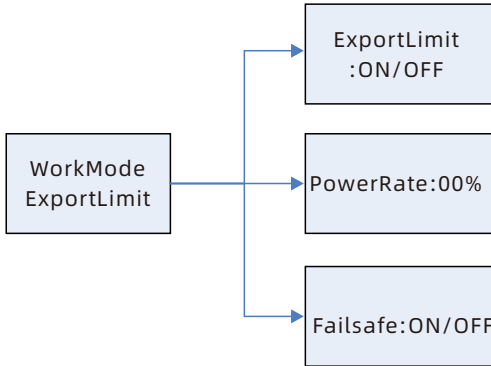

Figure 6. 13 Export Limit Settings

**Note:**

- 1. The default value is 00.0%.
- 2. The Fault Safety Function only works in meter mode.
- 3. The inverter has three control functions, which can be switched using ShineTools by modifying register 330. This register can be set to 1/2/3:

Setting 1 enables software limit control function.

Setting 2 enables hardware limit control function.

Setting 3 enables both software and hardware limit control functions.

e.g. Run the ShineTools APP, then select "Advanced" to enter the advanced settings interface. In the "Command Type" section, input "6"; in the "Register Address" section, input "330"; and in the "Length/Data" section, input the control mode "1"/"2"/"3".

H. Under "RS485 Setting", press "OK", and you can see the following settings options:



Figure 6. 14 RS485 settings

C. Under "Mode Change", press "OK", and you can see the following settings options:

Sensor Type: Cable CT (default), Master, and Meter.  
 Battery Type: Lithium battery or Lead-acid battery.

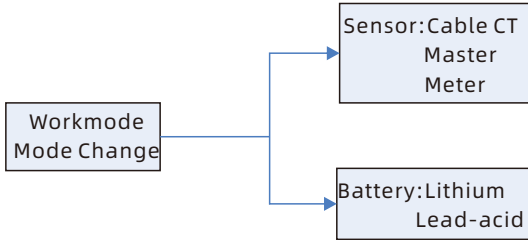

Figure 6. 15 Mode Change settings

J. Under "Priority", press "OK", and you can see the following settings options:

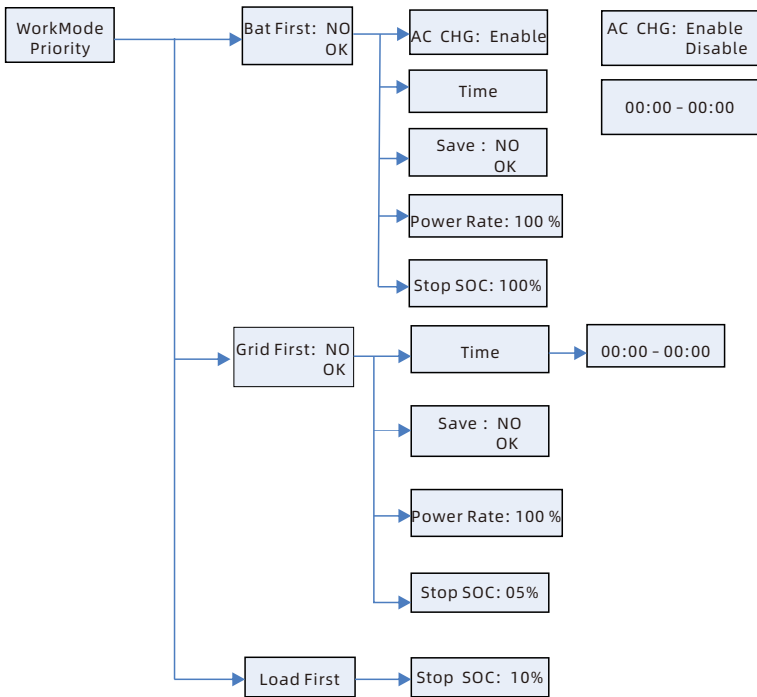

Figure 6. 16 Priority settings



**Note:**

1. "Power" is used to set the power of the battery. Since different batteries may have different power ratings, you need to check the maximum power of the battery.
2. Set the time format to 24 hours. If the end time is less than the start time, it defaults to spanning midnight.
3. SC initial default password is 1111.

K. Under "EPS", press OK for 1 second and you can see the following settings options:

You can set to enable or disable EPS. It is enabled by default. You can also configure the AC voltage (230V by default), frequency (50Hz by default), Bypass mode (ON by default), EPS Mode (ON by default), and N\_PE relay (OFF by default under Australian safety regulations).

**Note:**

When EPS is set to "Disable" and Bypass to "OFF", the EPS port has no output under any circumstances.

When EPS is set to "Enable" and Bypass to "OFF", there is no output from the EPS port when the grid is available, and there is output when the grid is unavailable.

When EPS is set to "Disable" and Bypass to "ON", there is output from the EPS port when the grid is available, and no output when the grid is unavailable.

When EPS is set to "Enable" and Bypass to "ON", the EPS port has output under any circumstances.

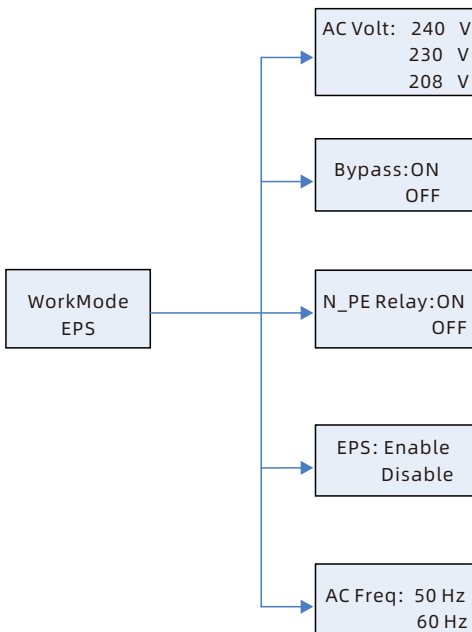

Figure 6. 17 EPS settings

L. To facilitate installation and diagnose any faults that may cause operational issues during installation, a one-click installation diagnostics function is added:

Before starting, please turn off the PV switch. During the installation diagnostics process, if customers have loads connected, please keep the loads running stable to ensure accurate testing. Long press the ESC key for 3 seconds to enter "Assemble Test". Press OK to start the one-click diagnostics.

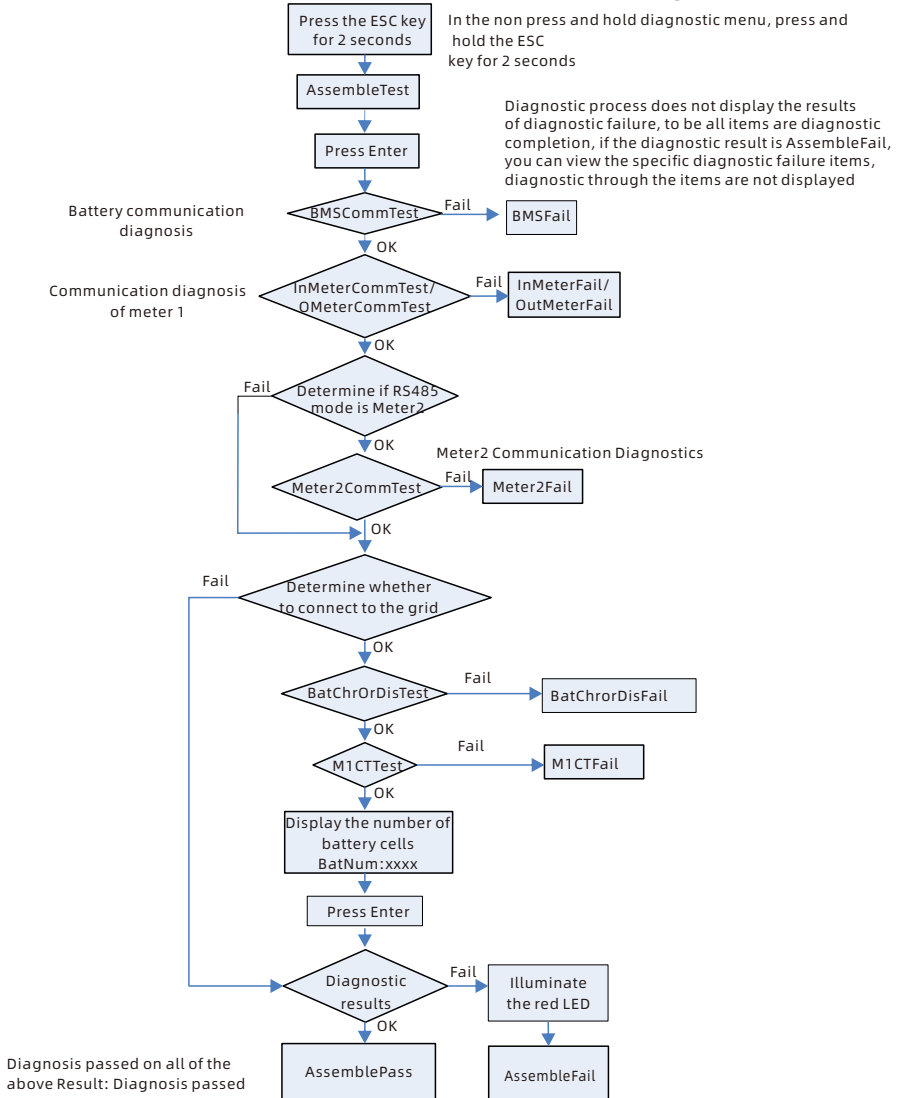

Figure 6. 18 One-click installation diagnostics settings

If there is a diagnostic failure for each of the above Result: Diagnostic failure, and you can view the diagnostic failure items.

- BMSFail :Lithium battery communication failure
  - InMeterFail: Internal Meter Communication Failure
  - OutMeterFail: External meter communication failure
  - Meter2Fail: Meter 2 communication failure
  - M1CTFail: C T reversed
  - BatChrOrDisFail: Battery charge/discharge failure
  - AC No Connect!!!: Grid Connection Fail
- Remarks: After exiting the installation diagnostics, the LEDs return to their original state.

Translated with DeepL.com (free version).

M. Check the firmware version, region, country/ area, and energy quality response mode.

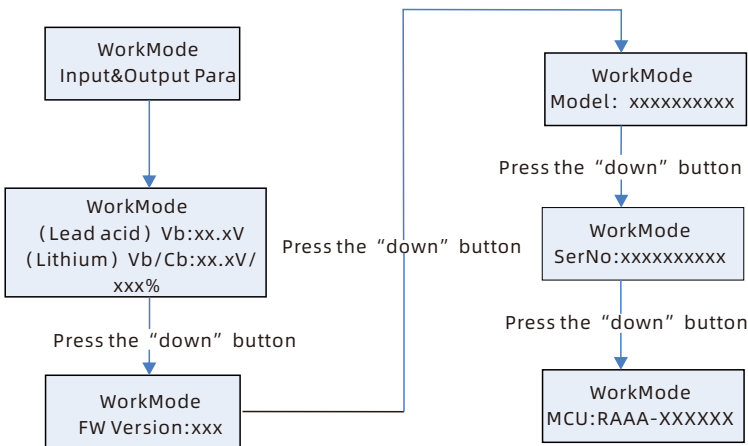

Figure 6. 19 Other settings

## 6.2 Datalogger Settings

1. Ensure the datalogger has been reliably connected.
2. Please use the Growatt datalogger, such as Wi-Fi-X/Shinelink-x/Shinewilan-X2.
3. Connect to the remote monitoring system. First download the APP, and proceed as prompted. For details, refer to the datalogger's manual.

### Note:

1. You need to use Growatt ShineServer/ShinePhone for data monitoring.
2. After connecting the datalogger, upon initial battery power-on, no monitoring data would be available in the first 20 minutes as the SPH is establishing communication with SPH, uploading information such as the battery SN.

# Specifications 7

## 7.1 ALP 5.0L-E1 Specifications

Parallel number	1	2	3	4
<b>Model</b>	<b>ALP 5.0L-E1</b>	<b>ALP 10.0L-E1</b>	<b>ALP 15.0L-E1</b>	<b>ALP 20.0L-E1</b>
Nominal Energy (kWh)	5	10	15	20
Rated Energy (kWh)	4.6	9.2	13.8	18.4
Nominal Capacity (Ah)	100	200	300	400
Rated Capacity (Ah)	90	180	270	360
Nominal Voltage (V)	51.2			
Voltage Range (V)	46.4 ~ 57.6			
Rated Current (A)	75	130	130	130
Max Current (A)	90	150	150	150
DoD	92%			
Operating temperature	0°C ~ 50°C			
Dimensions* <sup>2</sup> (mm)	690 * 185 * 295	690 * 185 * 590	690 * 185 * 885	690 * 185 * 1180
Weight* <sup>3</sup> (kg)	44	88	132	176
IP Rating	IP66			
Storage temperature	20°C ~50°C / 7 days; - 20°C ~40°C / 6 months; 95%RH			
Cooling Method	Natural cooling			
Installation method* <sup>4</sup>	Floor / Wall mount			
Cell Type	LFP			
Communication Method	CAN			
Scalability	A maximum of 8 battery modules can be connected in parallel			
Certified Product	IEC62619 /IEC 62040 /CE /UN38.3/ROHS			
BMS Monitoring Parameters	SOC, System voltage, current, cell voltage, cell temperature, PCBA temperature measurement			

Parallel number	5	6	7	8
Model	ALP 25.0L-E1	ALP 30.0L-E1	ALP 35.0L-E1	ALP 40.0L-E1
Nominal Energy (kWh)	25	30	35	40
Rated Energy (kWh)	23	27.6	32.2	36.8
Nominal Capacity (Ah)	500	600	700	800
Rated Capacity (Ah)	450	540	630	720
Nominal Voltage (V)	51.2			
Voltage Range (V)	46.4 ~ 57.6			
Rated Current (A)	130	130	130	130
Max Current (A)	150	150	150	150
DoD	92%			
Operating temperature	0°C ~ 50°C			
Dimensions* <sup>2</sup> (mm)	690 * 185 * 1475	690 * 185 * 1770	690 * 185 * 2065	690 * 185 * 2360
Weight* <sup>3</sup> (kg)	220	264	308	352
IP Rating	IP66			
Storage temperature	20°C ~50°C / 7 days; - 20°C ~40°C / 6 months; 95%RH			
Cooling Method	Natural cooling			
Installation method* <sup>4</sup>	Floor / Wall mount			
Cell Type	LFP			
Communication Method	CAN			
Scalability	A maximum of 8 battery modules can be connected in parallel			
Certified Product	IEC62619 /IEC 62040 /CE /UN38.3/ROHS			
BMS Monitoring Parameters	SOC, System voltage, current, cell voltage, cell temperature, PCBA temperature measurement			

1. Device performance will be affected when the temperature is below 0°C or above 45°C.
2. Height (base not included).
3. Weight (base not included).

## 7.2 SPH 3000-6000TL-HUB Specifications

Model Specifications	SPH 3000 TL-HUB	SPH 3600 TL-HUB	SPH 4000 TL-HUB	SPH 4600 TL-HUB	SPH 5000 TL-HUB	SPH 6000 TL-HUB
Input data (PV)						
Max. recommended PV power(for module STC) 6000W	6000W	7200W	8000W	9200W	10000W	12000W
Max. PV voltage**	600V					
Full load MPP Voltage Range	187.5V-470V	225V-470V	250V-470V	287.5V-470V	312.5V-470V	375V-470V
Start voltage	100V					
Nominal voltage	370V					
MPPT work voltage range	100V-560V					
Number of independent MPP trackers	2					
No. of PV strings per MPP tracker	1					
Max. input current per MPP tracker	16A					
Max. short-circuit current per MPP tracker	24A					
AC input /output data						
Rated output/input power	3000W	3680 W	4000 W	4600W	5000W	6000W
Rated output/input apparent power	3000VA	3680VA	4000VA	4600VA	5000VA	6000VA
Nominal AC voltage/range	230V; 180Vac-260Vac					
Nominal Frequency /range	50/60Hz; 45~55Hz/55~65 Hz					
Rated input / output current	13/ 13 A	16/16 A	17.3/17.3 A	20/20 A	21.7A/21.7A	26A/26A
Max. input / output current	16/16 A	16/16 A	22/22 A	22/22 A	27/27 A	27/27 A
Phase factor (@ rate power)	1					

Model Specifications	SPH 3000 TL -HUB	SPH 3600 TL-HUB	SPH 4000 TL-HUB	SPH 4600 TL-HUB	SPH 5000 TL-HUB	SPH 6000 TL-HUB
Adjustable power factor	0.8leading...0.8lagging					
THDI	<3%					
AC connection	Single phase					
EPS output date						
Rated output apparent power	3000VA	3680VA	4000VA	4600VA	5000VA	6000VA
Nominal voltage	230V					
Nominal Frequency	50/60Hz					
Rated output current	13A	16A	17.3A	20A	21.7A	26A
THDv	3%					
Switch time	≤15ms					
Efficiency						
Bat Online CEC weighted efficiency	93.4%					
PV Online CEC weighted efficiency	96.6%					
MPPT efficiency	≥99.5%					
BAT data (DC)						
Battery voltage range	42~59V					
Minimum full load voltage	46V	46V	46V	48V	48V	48V
Rated charging and discharging current	66/66 A	75/75 A	85/85 A	96/96 A	105/105 A	125/125 A
Continuous charging / discharging power	3000 W	3680 W	4000 W	4600 W	5000 W	6000 W
Type of Battery	lithium /Lead-acid					
Protection devices						
Overvoltage category	PV:II Bat:II AC:III					

Model Specifications	SPH 3000 TL -HUB	SPH 3600 TL-HUB	SPH 4000 TL-HUB	SPH 4600 TL-HUB	SPH 5000 TL-HUB	SPH 6000 TL-HUB
Inverter topology	Non-isolated					
Operating temperature range <sup>2</sup>	-25°C ... +60°C (-13...+140°F) with derating above 45°C /113°F					
Storage temperature range	-25°C ... +60°C (-13...+140°F) <sup>2</sup>					
Safety level	Class I					
Ingress protection	IP66					
AFCI	Integrated					
PV Switch	Integrated					
Bat Breaker	Integrated					
PV Surge protection	Type II					
Insulation resistance monitoring	Integrated					
AC surge protection	Type III					
AC short-circuit protection	Integrated					
Ground fault monitoring	Integrated					
Grid monitoring	Integrated					
Anti-islanding protection	Integrated(Active Frequency Drift)					
Residual-current monitoring unit	Integrated					
<b>General Data</b>						
Dimensions (W / H / D) in mm	690*692*1986					
Weight(KG)	35					
Noise emission (typical)	≤ 25 dB(A)					
Altitude	3000m					
Self-Consumption	< 10 W					



Model	SPH 3000 TL -HUB	SPH 3600 TL-HUB	SPH 4000 TL-HUB	SPH 4600 TL-HUB	SPH 5000 TL-HUB	SPH 6000 TL-HUB
Cooling concept	Natural					
Relative humidity	100%					
Features						
PV connection	VP-D4					
AC connection	connector					
BAT connection	connector					
Display	LCD					
Interfaces: RS485/ USB /CAN/WiFi/GPRS /ShineWiLan	yes /opt					
Warranty: 10 years	yes					
Certificates and approvals	CE, IEC62109, IEC61000, AS4777.2:2020, CEC					
Place of production	Made in China					

**Note:**

1. The maximum operating voltage for the inverter's PV input is 560V. If it exceeds 560V, the system will not work or will stop operating. The maximum input voltage is 600V, and exceeding this voltage poses a risk of damage. When the PV panel voltage is too high, the machine will derate for protection. The overvoltage derating curve is shown in the figure below:

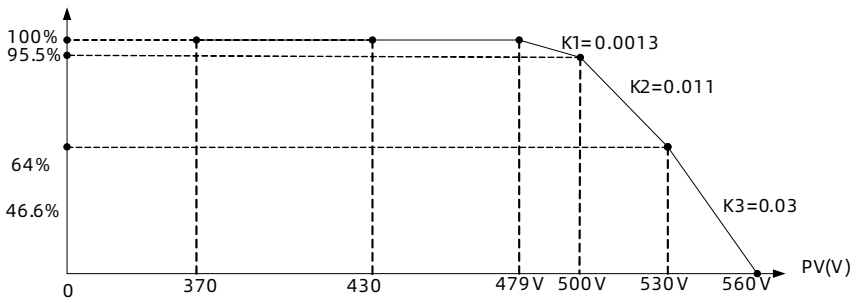

Figure 7. 1 SPH 3-6KTL-HUB PV side HV derating curve

2. When using ALP batteries, the recommended ambient temperature ranges from 0°C to 50°C.

# Troubleshooting 8

All Growatt products undergo rigorous testing before leaving the factory. If you encounter any difficulties during installation, please visit [www.ginverter.com](http://www.ginverter.com) and refer to the troubleshooting suggestions.

In case that the SPH inverter becomes faulty, please notify Growatt promptly and provide information about the SPH. To provide you with better support, please have the following information ready:

- Serial number
- Model number
- Info displayed on the LCD
- Brief description of the issue Battery voltage
- PV input voltage and power per string
- Grid voltage and frequency
- Can you describe the process of fault occurrence? What were the conditions?
- Has this issue occurred previously?
- When did this fault occur? During the first installation?
- Name and model of the battery manufacturer
- Battery capacity
- Battery output voltage
- When did you purchase the battery and how frequently is it used?

## 8.1 SPH Fault List and Troubleshooting Suggestions

Warning Message		
Error Message	Description	Suggestion
Warning 401	SP-CT/Meter Communication fault	<ol style="list-style-type: none"><li>1. Check the wire connection between meter and inverter is good or not.</li><li>2. Check if the distance between SP-CT and inverter is within the specified range.</li><li>3. Restart the inverter after confirming that the cable is properly connected.</li></ol>
Warning 203	PV1 or PV2 Circuit short	<ol style="list-style-type: none"><li>1. Check if the positive and negative poles of the PV input are reversed.</li><li>2. Reconnect the PV connectors. Please contact Growatt support if the problem persists.</li></ol>
Warning 506	Battery temperature out of specified range for charge or discharge	Check if the ambient temperature of the battery is beyond the specified range.

<b>Error Message</b>	<b>Description</b>	<b>Suggestion</b>
AC V Outrange	Grid voltage fault. Please refer to the local grid standard for more details of the grid voltage	<ol style="list-style-type: none"> <li>1. Check if the AC voltage is within the specified range.</li> <li>2. Check the grid connection.</li> </ol>
AC F Outrange	Grid frequency fault. Please refer to the local grid standard for more details for the grid frequency	<ol style="list-style-type: none"> <li>1. Check if the AC frequency is within the specified range.</li> <li>2. Restart the inverter.</li> <li>3. Contact Growatt support if the problem persists after restart.</li> </ol>
PairingTime Out	Communication fault	<ol style="list-style-type: none"> <li>1. Check if the distance between SP-CT and inverter is within the specified range.</li> <li>2. Restart inverter and SP-CT, reconnect.</li> </ol>
CT LN Reversed	LN Reversed	<ol style="list-style-type: none"> <li>1. Check whether the L line and N line of SP-CT is reversed or not.</li> <li>2. Check the connection of the SP-CT's PE wire.</li> </ol>
BMS COM Fault	Communication fault	<ol style="list-style-type: none"> <li>1. Check if the lithium battery has been turned on.</li> <li>2. Check the connection between the lithium battery and the inverter.</li> </ol>
Battery Open	Battery terminal open(only for lithium battery)	<ol style="list-style-type: none"> <li>1. Check the battery connection.</li> <li>2. Check if the switches between the battery and the inverter have been turned on.</li> </ol>
Over Load	EPS output overload warning. If this warning occurred three times, the off-grid function will be locked for one hour.	Please reduce the load connected to the EPS output port.
No AC Connection	No Utility	<ol style="list-style-type: none"> <li>1. Check if the grid goes down.</li> <li>2. Check the grid connection.</li> <li>3. Check if the switches have been turned on.</li> </ol>

<b>Error Message</b>	<b>Description</b>	<b>Suggestion</b>
Output High DCI	High DC component in the output power. Please refer to the local grid standard for disconnection time when the output DC current is too high.	<ol style="list-style-type: none"> <li>1. Restart the inverter.</li> <li>2. Please contact Growatt support if the problem persists after restart.</li> </ol>
Bat Voltage High	Battery Voltage higher than 60V	<ol style="list-style-type: none"> <li>1. Check if the battery voltage is within the specified range.</li> <li>2. Check the battery connection. If the actual battery voltage is higher than 60V, please disconnect the battery and check the inverter.</li> </ol>
Bat Voltage Low	Battery Voltage lower than 42 V	<ol style="list-style-type: none"> <li>1. Check if the battery voltage is within the specified range.</li> <li>2. Check the connection between the battery and the inverter.</li> </ol>
BMS Warning:XXX	BMS report warning	<ol style="list-style-type: none"> <li>1. Check the warning information referring to the lithium battery user manual.</li> <li>2. Please contact Growatt support if the problem persists after restart.</li> </ol>
BMS error:XXX	BMS report error	<ol style="list-style-type: none"> <li>1. Check the warning information referring to the lithium battery user manual.</li> <li>2. Please contact Growatt support if the problem persists after restart.</li> </ol>
EPS Volt Low	EPS output voltage low	<ol style="list-style-type: none"> <li>1. Check the power of the load connected to the EPS output port. If overload occurs, please reduce the load.</li> <li>2. Restart the inverter.</li> </ol>

<b>Error message</b>		
<b>Error Message</b>	<b>Description</b>	<b>Suggestion</b>
Error 411	Internal communication failed	<ol style="list-style-type: none"> <li>1. Restart the inverter.</li> <li>2. Please contact Growatt support if the problem persists after restart.</li> </ol>
Error 417	Sampling error	<ol style="list-style-type: none"> <li>1. Restart the inverter.</li> <li>2. Please contact Growatt support if the problem persists after restart.</li> </ol>
Error 418	DSP and COM firmware version unmatched, system fault.	<ol style="list-style-type: none"> <li>1. Read the DSP and COM firmware versions via the LCD or ShineBus.</li> <li>2. Check if the firmware is correct.</li> </ol>
Error 303	Inverter L N reversed or ground fault	<ol style="list-style-type: none"> <li>1. Check if the L line and N line are reversed.</li> <li>2. Check if the PE cable is properly connected.</li> </ol>
Error 405	Relay fault	<ol style="list-style-type: none"> <li>1. Restart the inverter.</li> </ol> Please contact Growatt support if the problem persists after restart.
Error 123	Auto test failed (only in Italy)	<ol style="list-style-type: none"> <li>1. Restart the inverter.</li> </ol> Please contact Growatt support if the problem persists after restart.
PV Isolation Low	PV isolation too low	<ol style="list-style-type: none"> <li>1. Check the wiring of the PV panels.</li> </ol> Check if the inverter's PE cable is properly connected.
OP Short Fault!	EPS Output Short Fault	<ol style="list-style-type: none"> <li>1. Check the load connected to the EPS port.</li> <li>2. Check if the EPS output is short-circuited.</li> </ol>
NTC Open	Internal temperature failed	Please contact Growatt support.
Residual I High	Leakage current too high	<ol style="list-style-type: none"> <li>1. Check the inverter wiring. Then restart the inverter.</li> <li>2. Please contact Growatt support if the problem persists after restart.</li> </ol>

Error message		
Error 408	Temperature over range	Check if the temperature is within the specified range.
PV Voltage High	PV voltage higher than the specification	Check if the PV input voltage is within the specified range.

## 8.2 Battery Fault List and Troubleshooting Suggestions

Error Indication	Error description	Error cause	Suggested actions
ALM			
* (ALM Light Flickers)	Discharge under-voltage protection	Single cell voltage is below the threshold for under-voltage protection	1. There is a risk of over-discharge. 2. User should stop discharging and arrange recharge
	Charge over voltage protection	Single cell voltage exceeds threshold for protection	1. There is no safety threat. 2. User should stop charging. Wait until the alarm disappears.
	External CAN Communication failure	Communication loss between PCS and PACK	1. There is no safety threat and user should stop using battery. 2. Check if PCS and battery communication terminal is well connected. 3. If the alarm persists after the communication wire is confirmed to be well-connected, user should contact the installer to repair the battery.

* (ALM Light Flickers)	Interior CAN Communication failure	Communication loss between two batteries	Check Can connection between two batteries, CAN connection between Linkin and Linkout.
	Parallel connection failure protection	Communication failure between two parallel-connected PACKs	Check Can connection between two batteries, CAN connection between Battery and PCS.
* (ALM Light on)	Discharge short circuit	External short circuit of PACK	1. There is safety risk and user should stop using the battery. 2. User should contact installer to repair PCS and battery.
	Precharge short circuit		
	Precharge overtime		
	Type inconsistency of PACK	The pack type is different	1. There is safety risk and user should stop using the battery 2. User should contact installer to use the same PACK in Parallel.
Main circuit fault	BMS main power circuit failure	1. There is safety risk and user should stop using the battery. 2. User should contact installer to repair battery.	

## 8.3 Decommissioning

### 8.3.1 Preparation

- Prepare safety gloves, a cross-head screwdriver, socket wrench, and other tools.
  - Power off the SPH system.
1. If the battery system is powered on, press the power button once to turn it off. Before performing maintenance on the battery, ensure to turn off the circuit breaker and confirm again that the battery system is powered off. Follow the installation and wiring procedures described above.
  2. Turn off the circuit breaker that connects the inverter to the grid.
  3. Turn off the PV-side isolation switch.
  4. Ensure that SPH is completely powered off, with the LCD screen turned off.
- Disconnect the wires in the system.

### 8.3.2 Remove the Inverter

1. Power off the system, referring to Section 5.2.
2. Disconnect all cables connected to the SPH.
3. Remove screws securing the SPH.
4. Remove the SPH.

#### Note:

After powering off the SPH inverter, do not open the cover until 5 minutes later as residual voltage exists, and it takes about 20 minutes for the inverter to cool down.

### 8.3.3 Pack the Inverter

Please handle the SPH inverter and the battery with care during transportation. Keep them level and try to keep the batteries at approximately 50% SOC (State of Charge) during handling.

### 8.3.4 Dispose of the Inverter



Do not dispose of the SPH inverter together with the household waste but in accordance with the disposal regulations for electronic waste applicable at the installation site.

## 8.4 Alarm Notifications

The remote communication function enables sending alarm notifications to designated contact person via e-mail over the network. The datalogger uploads the error to the OSS web, which then notifies the user via e-mail.

### 8.4.1 Requirements for Remote Communication

To enable the remote communication, you need to install a Growatt datalogger to connect to the Internet and upload data to the Growatt monitoring platform OSS.

The requirements are listed below:

The datalogger has been properly commissioned and can operate normally.

Communication has been successfully established between the inverter and the datalogger.

The system has been added to your OSS account on the website [oss.growatt.com](http://oss.growatt.com).

If a fault is detected, fault notifications will be sent to designated contacts once an hour until the fault is cleared.



### 8.4.2 Setting up Remote Reporting

- Once the energy storage system has been successfully added on the OSS, please follow steps below:

a) Open OSS, select your PV System, and navigate to “Settings” .

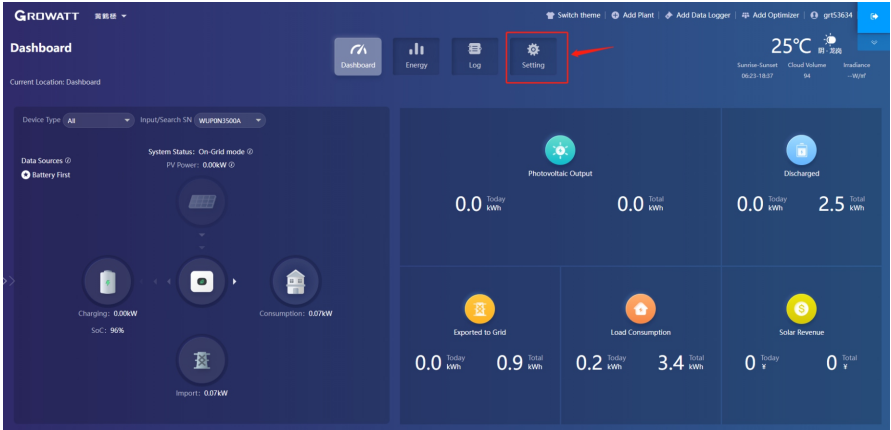

Figure 8. 1 OSS interface

b) Click “Add” under “E-mail Setting” section.

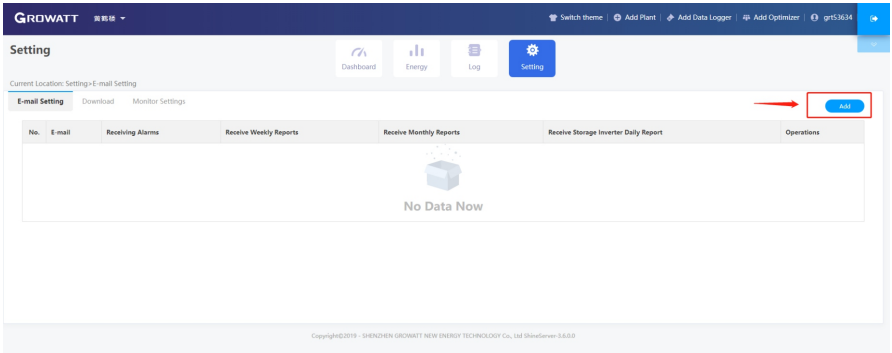

Figure 8. 2 Add the E-mail address

c) Enter the email address in the “E-mail” field, tick “Receiving Alarms”, and click “Yes”.

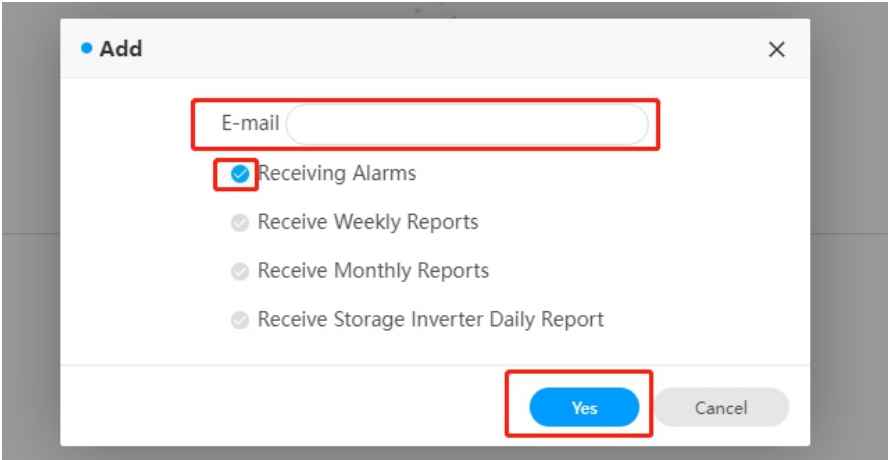

Figure 8. 3 Set E-mail notifications

d) Verify if the e-mail address has been successfully added.

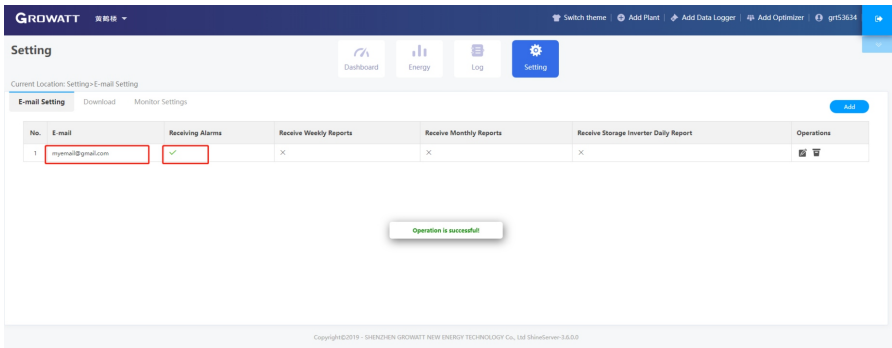

Figure 8. 4 E-mail setup succeeded

### 8.4.3 Check Historical Alarms

If an inverter error occurs (including the Earth Fault error), the system will automatically send alarm notifications to the e-mail address added in the previous step. Users can also check other historical alarms on the OSS by operating the following steps:

a) Open OSS, select the target system and navigate to “Log”.

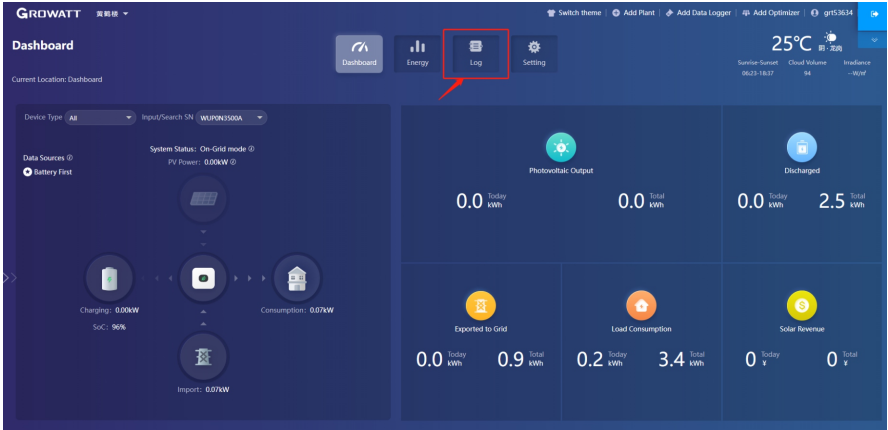

Figure 8. 5 Go to “Log”

b) Historical alarms will be shown in the area marked with a red box below.

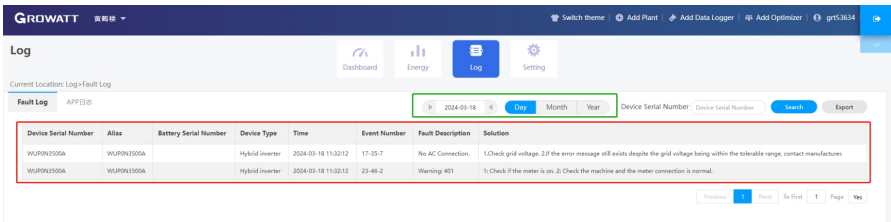

Figure 8. 6 Historical alarms

#### NOTE:

The historical alarms/messages (if any) are shown in the area marked with a red box. From the area marked with a green box, you can choose the date and to view the alarms by day/month/year.

# Appendix 9

## 9.1 Other Optional Accessories

The following chart lists optional accessories for the inverter. To place orders, you can contact Growatt or your dealer. (P/N is for reference only and subject to change.)

Name	Description	GROWATT P / N
Shine link-X	Used for data logging in EU	MR00 .0011200
	Used for data logging in Australia	MR00 .0011300
Shine Wi-Fi-X	COM interface	MR00 .0011000
SPM-CT-E (Single-phase CT meter)	Rs485 meter sensor	MR00 .0019000
SPM-E (Single-phase meter)	Rs485 meter sensor	MR00 .0008801
SPM-C (Single-phase meter)	Rs485 meter sensor	MR00 .0010801
TPM (Three-phase meter)	RS485 meter sensor (standard)	MR00 .0008300
	RS485 meter sensor (for Italy)	MR00 .0008400

## 9.2 Safety Standards

Model	Certificates
SPH 3000TL-HUB SPH 3600TL-HUB	CE, IEC62109, G98, VDE0126- 1- 1, AS4777, AS/NZS3100, CEI0- 21, VDE-AR-N4105, EN50438, VFR, MEA, PEA, IEC61727, IEC62116
SPH 4000TL-HUB SPH 4600TL-HUB SPH 5000TL-HUB SPH 6000TL-HUB	CE, IEC62109, G99, VDE0126- 1- 19, AS4777, AS/NZS3100, CEI0- 21, VDE-AR-N4105, EN50438, VFR, IEC61727, IEC62116



Download  
Manual



 [Growatt New Energy](#)

Shenzhen Growatt New Energy Co., Ltd.  
4-13/F, Building A, Sino-German (Europe) Industrial Park,  
Hangcheng Blvd, Bao'an District, Shenzhen, China

**T** +86 755 2747 1942  
**E** [service@ginverter.com](mailto:service@ginverter.com)  
**W** [en.growatt.com](http://en.growatt.com)

GR-UM-435-A-00 (PN:044.0124000)